

CS51 SOFTWARE ENGINEERING

UNIT I

SOFTWARE PRODUCT AND PROCESS

Software engineering paradigm:

- The framework activities will always be applied on every project ... BUT the tasks (and degree of rigor) for each activity will vary based on:
 - the type of project
 - characteristics of the project
 - common sense judgment; concurrence of the project team

The software process:

- A structured set of activities required to develop a software system
 - Specification;
 - Design;
 - Validation;
 - Evolution.
- A software process model is an abstract representation of a process. It presents a description of a process from some particular perspective.

Waterfall model/Linear Sequential Model/classic life cycle :

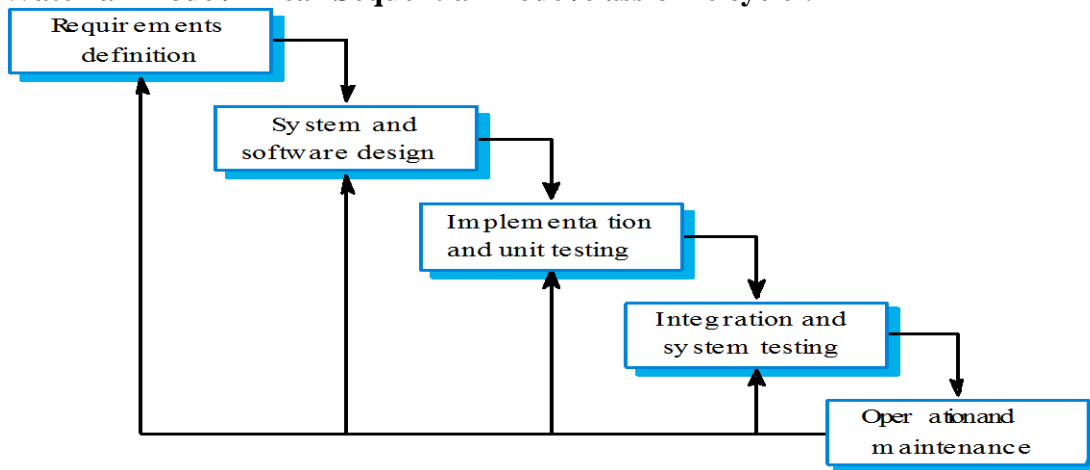

- **Systems Engineering**
 - Software *as part of larger system, determine requirements for all system elements, allocate requirements to software.*
- **Software Requirements Analysis**
 - Develop understanding of problem domain, user needs, function, performance, interfaces, ...
 - *Software Design*
 - *Multi-step process to determine architecture, interfaces, data structures, functional detail. Produces (high-level) form that can be checked for quality, conformance before coding.*
- **Coding**
 - Produce machine readable and executable form, match HW, OS and design needs.
- **Testing**

- Confirm that components, subsystems and complete products meet requirements, specifications and quality, find and fix defects.
- **Maintenance**
 - Incrementally, *evolve software* to fix defects, add features, adapt to new condition. Often 80% of effort spent here!

Waterfall model phases:

- Requirements analysis and definition
- System and software design
- Implementation and unit testing
- Integration and system testing
- Operation and maintenance
- The main drawback of the waterfall model is the difficulty of accommodating change after the process is underway. One phase has to be complete before moving onto the next phase.
- Each phase terminates only when the documents are complete and approved by the SQA group.
- Maintenance begins when the client reports an error after having accepted the product. It could also begin due to a change in requirements after the client has accepted the product

Waterfall model: Advantages:

- Disciplined approach
- Careful checking by the Software Quality Assurance Group at the end of each phase.
- Testing in each phase.
- Documentation available at the end of each phase.

Waterfall model problems:

- It is difficult to respond to changing customer requirements.
- Therefore, this model is only appropriate when the requirements are well-understood and changes will be fairly limited during the design process.
- Few business systems have stable requirements.
- The waterfall model is mostly used for large systems engineering projects where a system is developed at several sites.
- The customer must have patience. A working version of the program will not be available until late in the project time-span
- Feedback from one phase to another might be too late and hence expensive.

The Prototyping Models:

- Often, a customer defines a set of general objectives for software but does not identify detailed input, processing, or output requirements.
- In other cases, the developer may be unsure of the efficiency of an algorithm, the adaptability of an operating system, or the form that human –machine interaction should take
- In this case prototyping paradigm may offer the best approach
- Requirements gathering
- Quick design
- Prototype building
- Prototype evaluation by customers
- Prototype may be refined

- Prototype thrown away and software developed using formal process{ it is used to define the requirement } Prototyping

Strengths:

- Requirements can be set earlier and more reliably
- Customer sees results very quickly.
- Customer is educated in what is possible helping to refine requirements.
- Requirements can be communicated more clearly and completely
- Between developers and clients Requirements and design options can be investigated quickly and Cheaply

Weaknesses:

- Requires a rapid prototyping tool and expertise in using it—a cost for the development organisation
- Smoke and mirrors - looks like a working version, but it is not.

The RAD Model:

- Rapid Application Development is a linear sequential software development process model that emphasizes an extremely short development cycle
- Rapid application achieved by using a component based construction approach
- If requirements are well understood and project scope is constrained the RAD process enables a development team to create a “fully functional system”

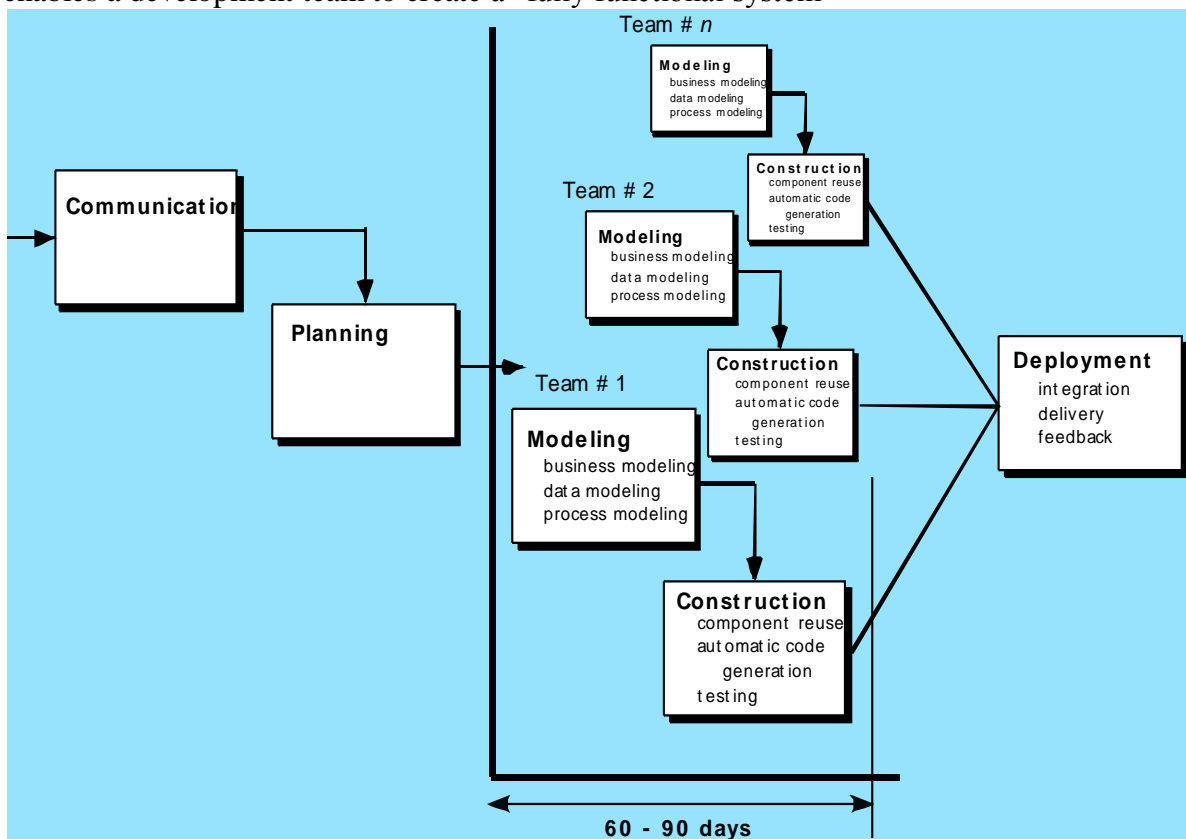
**RAD phases :**

- Business modeling
- Data modeling
- Process modeling

- Application generation
- Testing and turnover

Business modeling:

- What information drives the business process?
- What information is generated?
- Who generates it?

Data Modeling:

- The information flow defined as part of the business modeling phase is refined into a set of data objects that are needed to support the business.
- The characteristics (called attributes) of each object are identified and the relationships between these objects are defined

Process modeling:

- *The data modeling phase are transformed to achieve the information flow necessary to implement a business function.*
- *Processing descriptions are created for adding , modifying, deleting, or retrieving a data object*

Application generation:

- *RAD assumes the use of 4 generation techniques.*
- *Rather than creating software using conventional 3 generation programming languages, the RAD process works to reuse existing program components (when possible) or created reusable components (when necessary)*

Testing and Turnover:

- *Since the RAD process emphasizes reuse, many of the program components have already been testing.*
- *This reduces over all testing time.*
- *However, new components must be tested and all interfaces must be fully exercised*

Advantages & Disadvantages of RAD:

Advantages

- *Extremely short **development** time.*
- *Uses component-based construction and emphasises reuse and code generation*

Disadvantages

- ***Large human resource requirements (to create all of the teams).***
- *Requires strong commitment between developers and customers for “**rapid-fire**” activities.*
- ***High performance requirements maybe can't be met (requires tuning the components).***

The Incremental Model

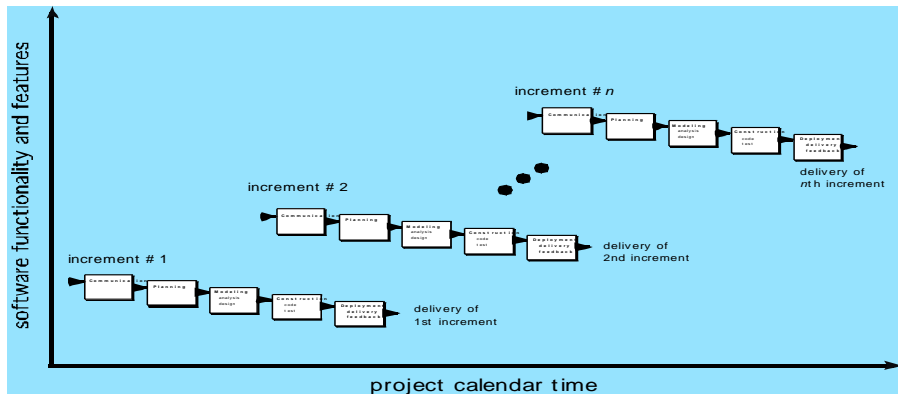

The Incremental development

- *Combination of linear + prototype*
 - *Rather than deliver the system as a single delivery, the development and delivery is broken down into increments with each increment delivering part of the required functionality*
 - User requirements are prioritised and the highest priority requirements are included in early increments
 - Once the development of an increment is started, the requirements are frozen though requirements for later increments can continue to evolve
- Incremental development advantages:
- The customer is able to do some useful work after release
 - Lower risk of overall project failure
 - The highest priority system services tend to receive the most testing

Spiral Model:

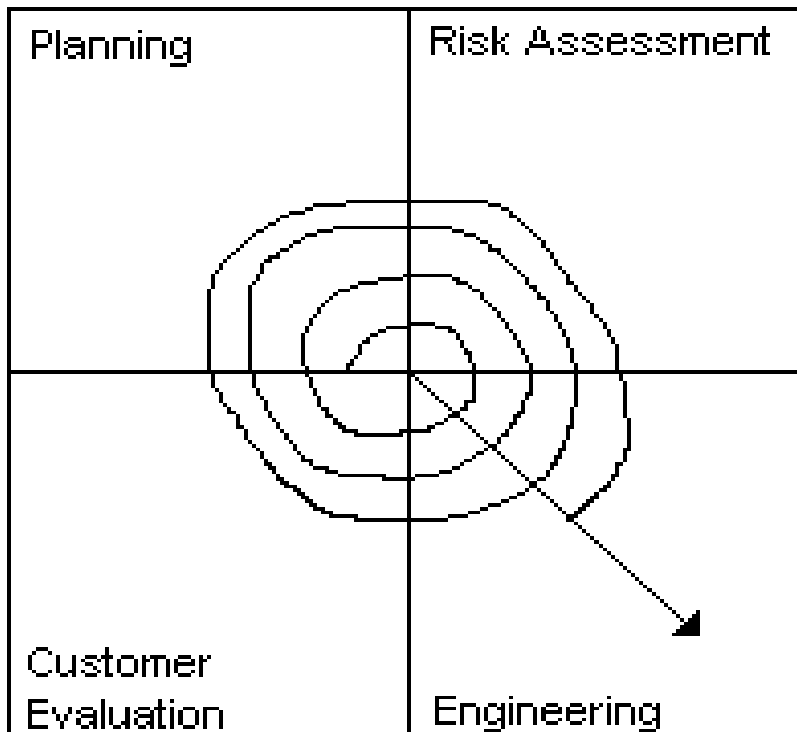

Spiral model sectors:

- Customer communication
 - Tasks required to establish effective communication between developer and customer
- Planning
 - The tasks required to define recourses, timelines, and project is reviewed and the next phase of the spiral is planned
- Risk analysis
 - Risks are assessed and activities put in place to reduce the key
- Risks engineering
 - Tasks required to build one or more representations of the application

- Construction & release
 - Tasks required to construct, test, install and provide user support (e.g documentation and training)
- Customer evaluation
 - Customer feedback collected every stage

Spiral Model Advantages:

- Focuses attention on reuse options.
- Focuses attention on early error elimination.
- Puts quality objectives up front.
- Integrates development and maintenance.
- Provides a framework for hardware/software Development.

System Engineering

- Software engineering occurs as a consequence of a process called system engineering.
- Instead of concentrating solely on software, system engineering focuses on a variety of elements, analyzing, designing, and organizing those elements into a system that can be a product, a service, or a technology for the transformation of information or control.

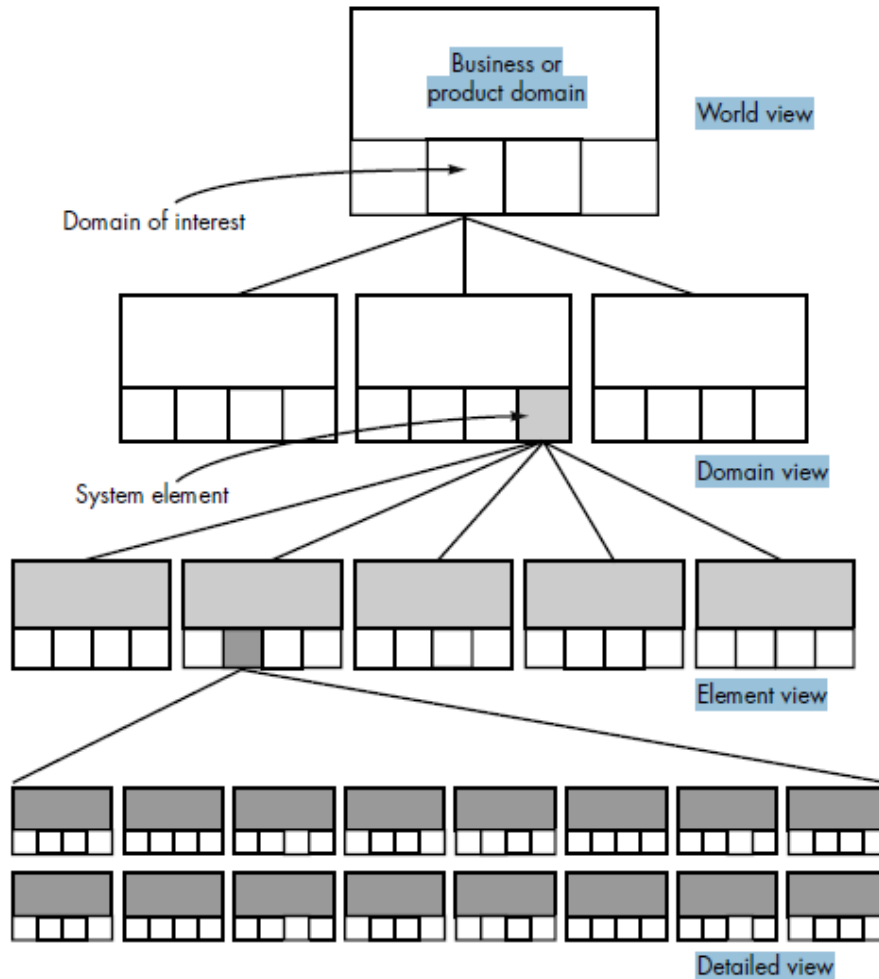

- The system engineering process usually begins with a “world view.” That is, the entire business or product domain is examined to ensure that the proper business or technology context can be established.
- The world view is refined to focus more fully on specific domain of interest. Within a specific domain, the need for targeted system elements (e.g., data, software, hardware, people) is analyzed. Finally, the analysis, design, and construction of a targeted system element is initiated.
- At the top of the hierarchy, a very broad context is established and, at the bottom, detailed technical activities, performed by the relevant engineering discipline (e.g., hardware or software engineering), are conducted.
- Stated in a slightly more formal manner, the world view (WV) is composed of a set of domains (D_i), which can each be a system or system of systems in its own right.

$$WV = \{D_1, D_2, D_3, \dots, D_n\}$$

- Each domain is composed of specific elements (E_j) each of which serves some role in accomplishing the objective and goals of the domain or component:

$$D_i = \{E_1, E_2, E_3, \dots, E_m\}$$

- Finally, each element is implemented by specifying the technical components (C_k) that achieve the necessary function for an element:

$$E_j = \{C_1, C_2, C_3, \dots, C_k\}$$

Computer Based System

- computer-based system as A set or arrangement of elements that are organized to accomplish some predefined goal by processing information.
- The goal may be to support some business function or to develop a product that can be sold to generate business revenue.
- To accomplish the goal, a computer-based system makes use of a variety of system elements:
 1. **Software.** Computer programs, data structures, and related documentation that serve to effect the logical method, procedure, or control that is required.
 2. **Hardware.** Electronic devices that provide computing capability, the interconnectivity devices (e.g., network switches, telecommunications devices) that enable the flow of data, and electromechanical devices (e.g., sensors, motors, pumps) that provide external world function.
 3. **People.** Users and operators of hardware and software.
 4. **Database.** A large, organized collection of information that is accessed via software.
 5. **Documentation.** Descriptive information (e.g., hardcopy manuals, on-line help files, Web sites) that portrays the use and/or operation of the system.
 6. **Procedures.** The steps that define the specific use of each system element or the procedural context in which the system resides.
- The elements combine in a variety of ways to transform information. For example, a marketing department transforms raw sales data into a profile of the typical purchaser of a product; a robot transforms a command file containing specific instructions into a set of control signals that cause some specific physical action.
- Creating an information system to assist the marketing department and control software to support the robot both require system engineering.

- One complicating characteristic of computer-based systems is that the elements constituting one system may also represent one macro element of a still larger system. The macro element is a computer-based system that is one part of a larger computer-based system.
- As an example, we consider a "factory automation system" that is essentially a hierarchy of systems. At the lowest level of the hierarchy we have a numerical control machine, robots, and data entry devices.
- Each is a computerbased system in its own right. The elements of the numerical control machine include electronic and electromechanical hardware (e.g., processor and memory, motors, sensors), software (for communications, machine control, interpolation), people (the machine operator), a database (the stored NC program), documentation, and procedures.
- A similar decomposition could be applied to the robot and data entry device. Each is a computer-based system.
- At the next level in the hierarchy, a manufacturing cell is defined. The manufacturing cell is a computer-based system that may have elements of its own (e.g., computers, mechanical fixtures) and also integrates the macro elements that we have called numerical control machine, robot, and data entry device.

Business Process Engineering Overview

- The goal of business process engineering (BPE) is to define architectures that will enable a business to use information effectively.
- When taking a world view of a company's information technology needs, there is little doubt that system engineering is required. Not only is the specification of the appropriate computing architecture required, but the software architecture that populates the "unique configuration of heterogeneous computing resources" must be developed.
- Business process engineering is one approach for creating an overall plan for implementing the computing architecture .
- Three different architectures must be analyzed and designed within the context of business objectives and goals:
 - data architecture
 - applications architecture
 - technology infrastructure
- The *data architecture* provides a framework for the information needs of a business or business function. The individual building blocks of the architecture are the data objects that are used by the business. A data object contains a set of attributes that define some aspect, quality, characteristic, or descriptor of the data that are being described.
- The *application architecture* encompasses those elements of a system that transform objects within the data architecture for some business purpose. In the context of this book, we consider the application architecture to be the system of programs (software) that performs this transformation. However, in a broader context, the application architecture might incorporate the role of people (who are information transformers and users) and business procedures that have not been automated.
- The *technology infrastructure* provides the foundation for the data and application architectures. The infrastructure encompasses the hardware and software that are used to support the application and data. This includes computers, operating systems, networks, telecommunication links, storage technologies, and the architecture (e.g., client/server) that has been designed to implement these technologies.

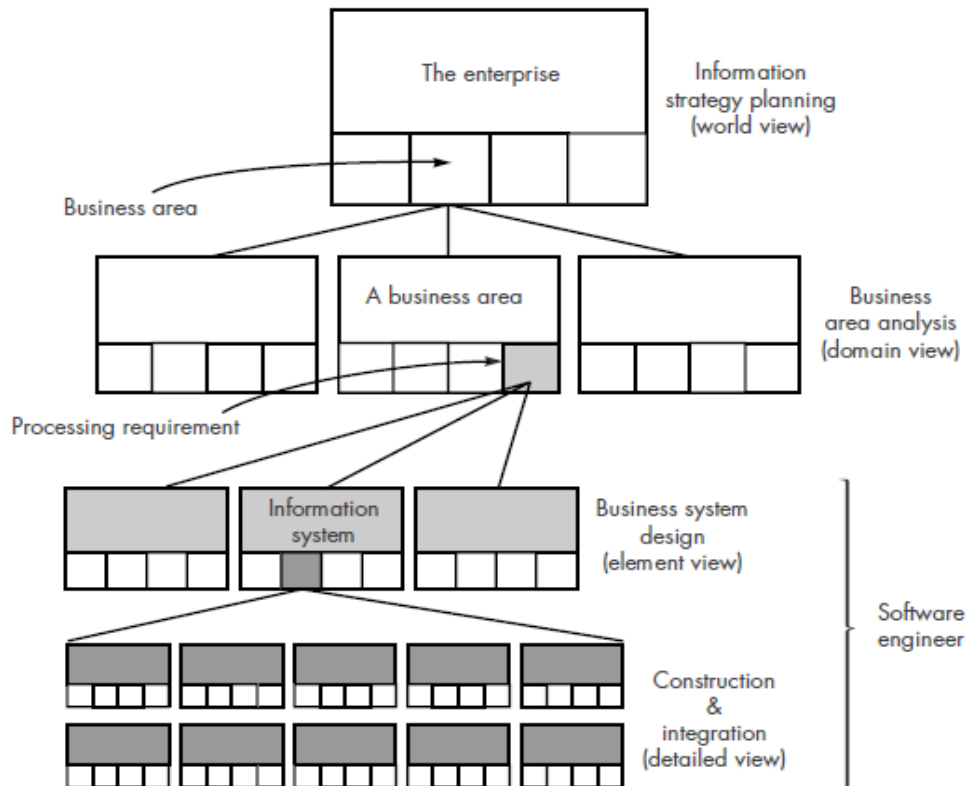

- The final BPE step—*construction and integration* focuses on implementation detail. The architecture and infrastructure are implemented by constructing an appropriate database and internal data structures, by building applications using software components, and by selecting appropriate elements of a technology infrastructure to support the design created during BSD. Each of these system components must then be integrated to form a complete information system or application.
- The integration activity also places the new information system into the business area context, performing all user training and logistics support to achieve a smooth transition.

Product Engineering Overview

- The goal of product engineering is to translate the customer's desire for a set of defined capabilities into a working product. To achieve this goal, product engineering—like business process engineering—must derive architecture and infrastructure.
- The architecture encompasses four distinct system components: software, hardware, data (and databases), and people. A support infrastructure is established and includes the technology required to tie the components together and the information (e.g., documents, CD-ROM, video) that is used to support the components.
- The world view is achieved through requirements engineering. The overall requirements of the product are elicited from the customer. These requirements encompass information and control needs, product function and behavior, overall product performance, design and interfacing constraints, and other special needs.
- Once these requirements are known, the job of requirements engineering is to allocate function and behavior to each of the four components noted earlier. Once allocation has occurred, system component engineering commences.

- System component engineering is actually a set of concurrent activities that address each of the system components separately: software engineering, hardware engineering, human engineering, and database engineering.

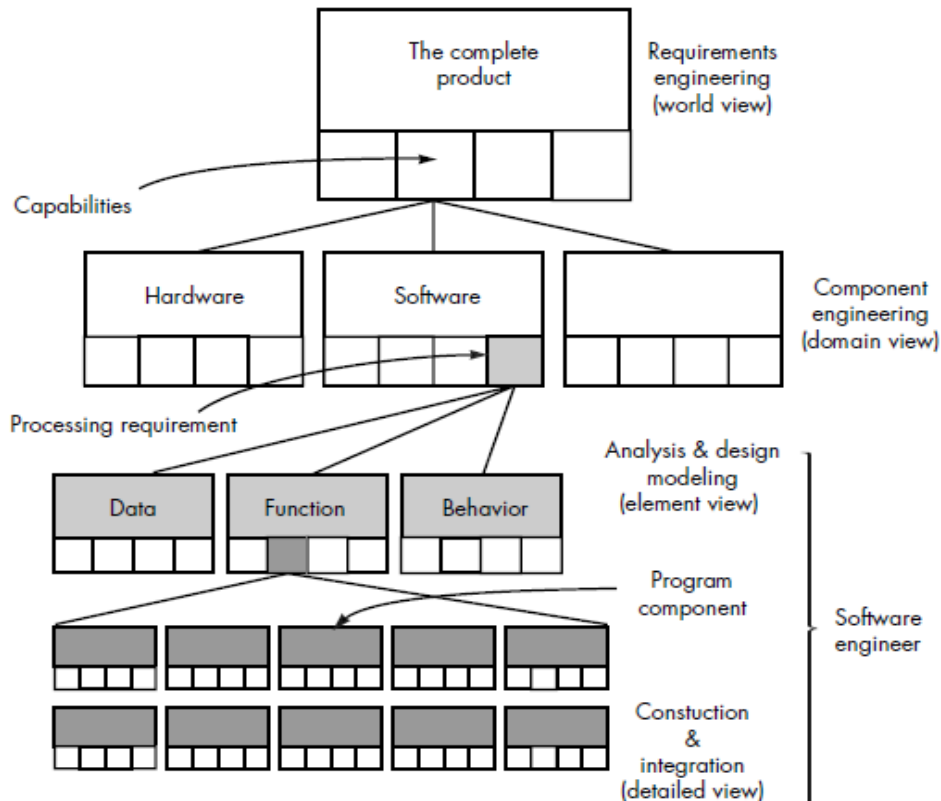

- Each of these engineering disciplines takes a domain-specific view, but it is important to note that the engineering disciplines must establish and maintain active communication with one another. Part of the role of requirements engineering is to establish the interfacing mechanisms that will enable this to happen.
- The element view for product engineering is the engineering discipline itself applied to the allocated component. For software engineering, this means analysis and design modeling activities (covered in detail in later chapters) and construction and integration activities that encompass code generation, testing, and support steps.
- The analysis step models allocated requirements into representations of data, function, and behavior. Design maps the analysis model into data, architectural, interface, and software component-level designs.

UNIT II

SOFTWARE REQUIREMENTS

- The process of establishing the services that the customer requires from a system and the constraints under which it operates and is developed
- Requirements may be functional or non-functional
 - Functional requirements describe system services or functions
 - Non-functional requirements is a constraint on the system or on the development process

Types of requirements

- User requirements
 - Statements in natural language (NL) plus diagrams of the services the system provides and its operational constraints. Written for customers
- System requirements
 - A structured document setting out detailed descriptions of the system services. Written as a contract between client and contractor
- Software specification
 - A detailed software description which can serve as a basis for a design or implementation. Written for developers

Functional and Non-Functional

Functional requirements

- Functionality or services that the system is expected to provide.
- Functional requirements may also explicitly state what the system shouldn't do.
- Functional requirements specification should be:
 - Complete: All services required by the user should be defined
 - Consistent: should not have contradictory definition (also avoid ambiguity → don't leave room for different interpretations)

Examples of functional requirements

- The LIBSYS system
- A library system that provides a single interface to a number of databases of articles in different libraries.
- Users can search for, download and print these articles for personal study.
- The user shall be able to search either all of the initial set of databases or select a subset from it.
- The system shall provide appropriate viewers for the user to read documents in the document store.
- Every order shall be allocated a unique identifier (ORDER_ID) which the user shall be able to copy to the account's permanent storage area.

Non-Functional requirements

- Requirements that are not directly concerned with the specific functions delivered by the system
- Typically relate to the system as a whole rather than the individual system features
- Often could be deciding factor on the survival of the system (e.g. reliability, cost, response time)

Non-Functional requirements classifications:

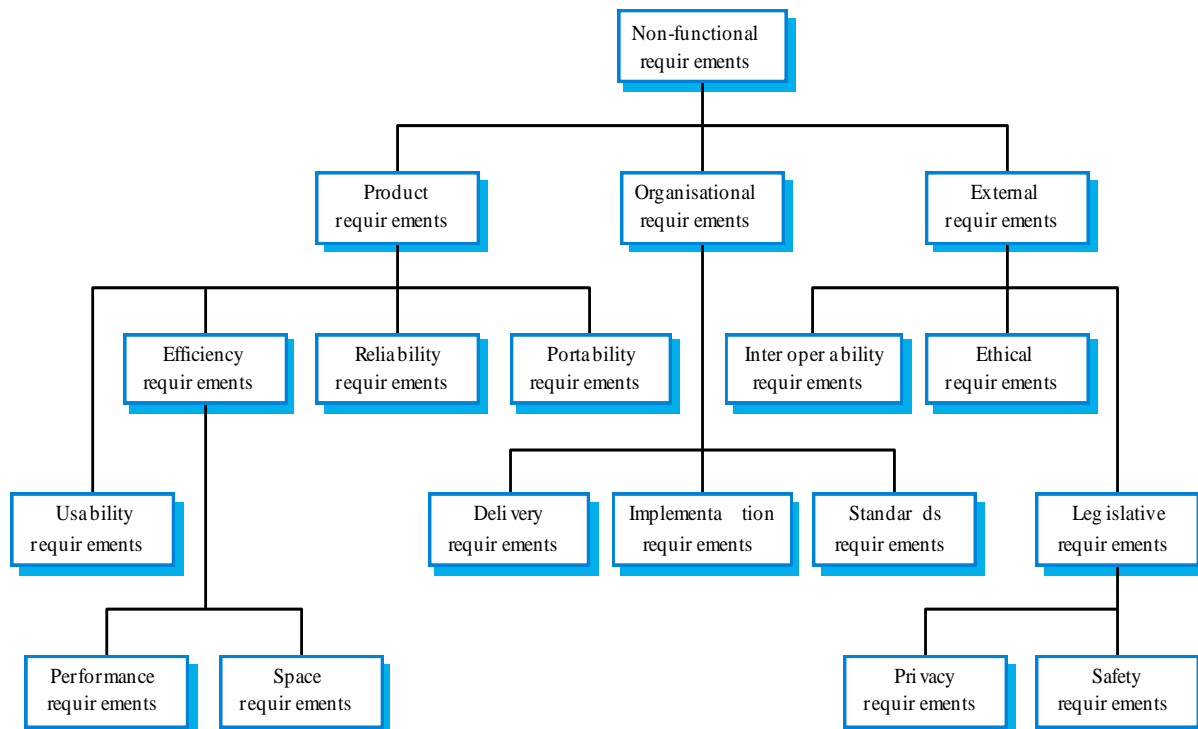

Domain requirements

- Domain requirements are derived from the application domain of the system rather than from the specific needs of the system users.
- May be new functional requirements, constrain existing requirements or set out how particular computation must take place.
- Example: tolerance level of landing gear on an aircraft (different on dirt, asphalt, water), or what happens to fiber optics line in case of severe weather during winter Olympics (Only domain-area experts know)

Product requirements

- Specify the desired characteristics that a system or subsystem must possess.
- Most NFRs are concerned with specifying constraints on the behaviour of the executing system.

Specifying product requirements

- Some product requirements can be formulated precisely, and thus easily quantified
 - Performance
 - Capacity

- Others are more difficult to quantify and, consequently, are often stated informally
 - Usability

Process requirements

- Process requirements are constraints placed upon the development process of the system
- Process requirements include:
 - Requirements on development standards and methods which must be followed
 - CASE tools which should be used
 - The management reports which must be provided

Examples of process requirements

- The development process to be used must be explicitly defined and must be conformant with ISO 9000 standards
- The system must be developed using the XYZ suite of CASE tools
- Management reports setting out the effort expended on each identified system component must be produced every two weeks
- A disaster recovery plan for the system development must be specified

External requirements

- May be placed on both the product and the process
- Derived from the environment in which the system is developed
- External requirements are based on:
 - application domain information
 - organisational considerations
 - the need for the system to work with other systems
 - health and safety or data protection regulations
 - or even basic natural laws such as the laws of physics

Examples of external requirements

- Medical data system The organisation's data protection officer must certify that all data is maintained according to data protection legislation before the system is put into operation.
- Train protection system The time required to bring the train to a complete halt is computed using the following function:
- The deceleration of the train shall be taken as:

$$g_{\text{train}} = g_{\text{control}} + g_{\text{gradient}}$$

where:

$g_{\text{gradient}} = 9.81 \text{ ms}^{-2} * \text{compensated gradient} / \alpha$ and where the values of $9.81 \text{ ms}^{-2} / \alpha$ are known for the different types of train.

g_{control} is initialised at 0.8 ms^{-2} - this value being parameterised in order to remain adjustable. The illustrates an example of the train's deceleration by using the parabolas derived from the above formula where there is a change in gradient before the (predicted) stopping point of the train.

Software Document

- Should provide for communication among team members

- Should act as an information repository to be used by maintenance engineers
- Should provide enough information to management to allow them to perform all program management related activities
- Should describe to users how to operate and administer the system
- Specify external system behaviour
- Specify implementation constraints
- Easy to change
- Serve as reference tool for maintenance
- Record forethought about the life cycle of the system i.e. predict changes
- Characterise responses to unexpected events

Users of a requirements document

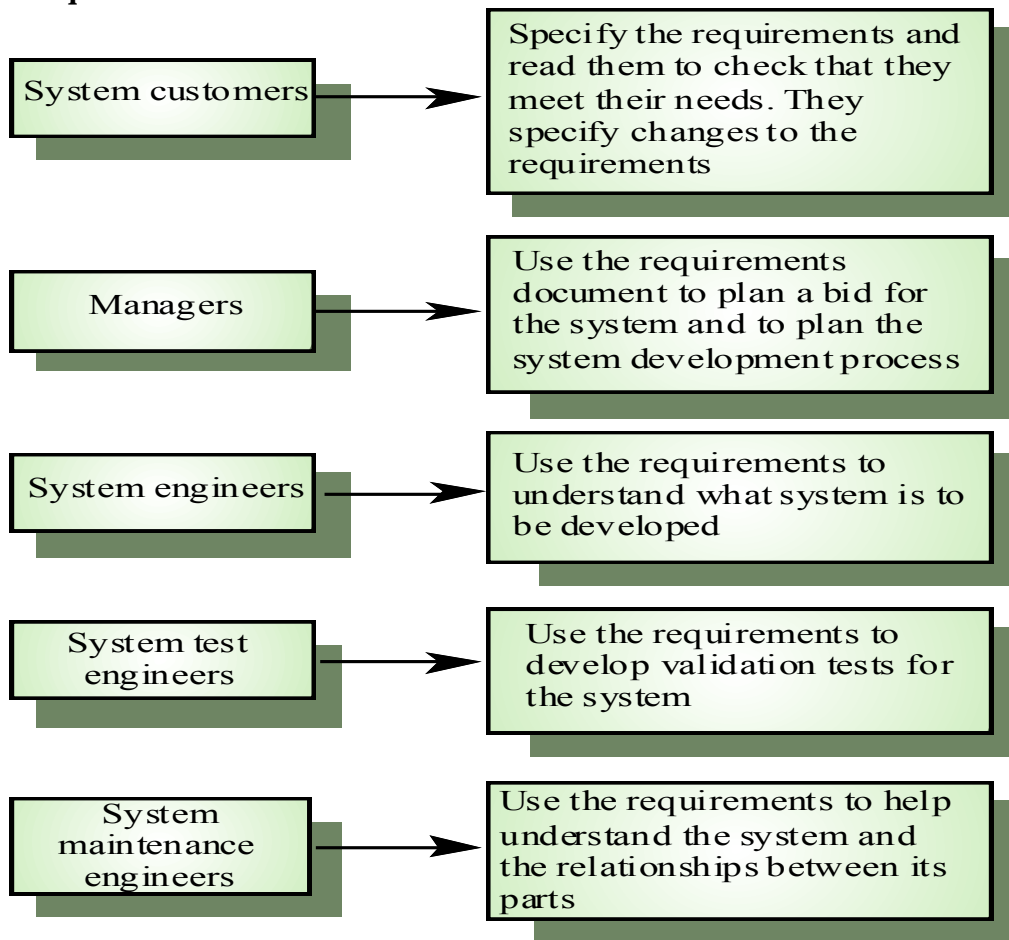

Process Documentation

- Used to record and track the development process
 - Planning documentation
 - Cost, Schedule, Funding tracking
 - Schedules
 - Standards

- This documentation is created to allow for successful management of a software product
- Has a relatively short lifespan
 - Only important to internal development process
 - Except in cases where the customer requires a view into this data
- Some items, such as papers that describe design decisions should be extracted and moved into the *product* documentation category when they become implemented
 - Product Documentation
- Describes the delivered product
- Must evolve with the development of the software product
- Two main categories:
 - System Documentation
 - User Documentation

Product Documentation

- System Documentation
 - Describes how the system works, but not how to operate it
- Examples:
 - Requirements Spec
 - Architectural Design
 - Detailed Design
 - Commented Source Code
 - Including output such as JavaDoc
 - Test Plans
 - Including test cases
 - V&V plan and results
 - List of Known Bugs
- User Documentation has two main types
 - End User
 - System Administrator
 - In some cases these are the same people
 - The target audience must be well understood!
- There are five important areas that should be documented for a formal release of a software application
 - These do not necessarily each have to have their own document, but the topics should be covered thoroughly
- Functional Description of the Software
- Installation Instructions
- Introductory Manual
- Reference Manual
- System Administrator's Guide

Document Quality

- Providing thorough and professional documentation is important for any size product development team

- The problem is that many software professionals lack the writing skills to create professional level documents

Document Structure

- All documents for a given product should have a similar structure
 - A good reason for product standards
- The IEEE Standard for User Documentation lists such a structure
 - It is a superset of what most documents need
- The authors “best practices” are:
- Put a cover page on all documents
- Divide documents into chapters with sections and subsections
- Add an index if there is lots of reference information
- Add a glossary to define ambiguous terms

Standards

- Standards play an important role in the development, maintenance and usefulness of documentation
- Standards can act as a basis for quality documentation
 - But are not good enough on their own
 - Usually define high level content and organization
- There are three types of documentation standards

1.Process Standards

- Define the approach that is to be used when creating the documentation
- Don’t actually define any of the content of the documents

2. Product Standards

- Goal is to have all documents created for a specific product attain a consistent structure and appearance
 - Can be based on organizational or contractually required standards
- Four main types:
 - Documentation Identification Standards
 - Document Structure Standards
 - Document Presentation Standards
 - Document Update Standards
- One caveat:
 - Documentation that will be viewed by end users should be created in a way that is best consumed and is most attractive to them
 - Internal development documentation generally does not meet this need

3. Interchange Standards

- Deals with the creation of documents in a format that allows others to effectively use
 - PDF may be good for end users who don’t need to edit
 - Word may be good for text editing

- Specialized CASE tools need to be considered
- This is usually not a problem within a single organization, but when sharing data between organizations it can occur
 - This same problem is faced all the time during software integration

Other Standards

- IEEE
 - Has a published standard for user documentation
 - Provides a structure and superset of content areas
 - Many organizations probably won't create documents that completely match the standard
- Writing Style
 - Ten "best practices" when writing are provided
 - Author proposes that group edits of important documents should occur in a similar fashion to software walkthroughs

Requirement Engineering Process

- The requirements engineering process includes a feasibility study, requirements elicitation and analysis, requirements specification and requirements management

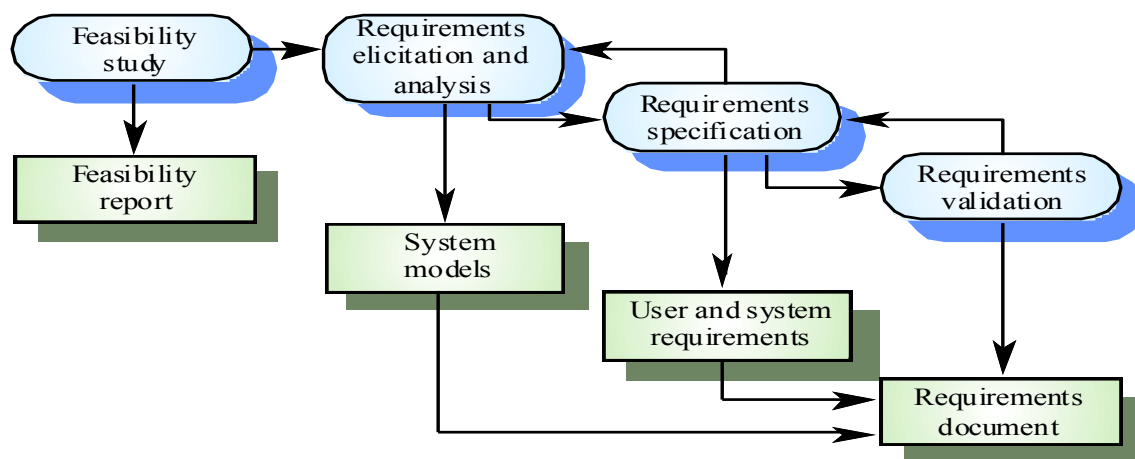

Feasibility Studies

- A feasibility study decides whether or not the proposed system is worthwhile
- A short focused study that checks
 - If the system contributes to organisational objectives
 - If the system can be engineered using current technology and within budget
 - If the system can be integrated with other systems that are used
- Based on information assessment (what is required), information collection and report writing
- Questions for people in the organisation
 - What if the system wasn't implemented?
 - What are current process problems?
 - How will the proposed system help?

- What will be the integration problems?
- Is new technology needed? What skills?
- What facilities must be supported by the proposed system?

Elicitation and analysis

- Sometimes called requirements elicitation or requirements discovery
- Involves technical staff working with customers to find out about
 - the application domain
 - the services that the system should provide
 - the system's operational constraints
- May involve end-users, managers, engineers involved in maintenance, domain experts, trade unions, etc.
 - These are called stakeholders

Problems of requirements analysis

- Stakeholders don't know what they really want
- Stakeholders express requirements in their own terms
- Different stakeholders may have conflicting requirements
- Organisational and political factors may influence the system requirements
- The requirements change during the analysis process
 - New stakeholders may emerge and the business environment change

System models

- Different models may be produced during the requirements analysis activity
- Requirements analysis may involve three structuring activities which result in these different models
 - Partitioning – Identifies the structural (part-of) relationships between entities
 - Abstraction – Identifies generalities among entities
 - Projection – Identifies different ways of looking at a problem
- System models will be covered on January 30

Scenarios

- Scenarios are descriptions of how a system is used in practice
- They are helpful in requirements elicitation as people can relate to these more readily than abstract statement of what they require from a system
- Scenarios are particularly useful for adding detail to an outline requirements description

Ethnography

- A social scientist spends a considerable time observing and analysing how people actually work
- People do not have to explain or articulate their work
- Social and organisational factors of importance may be observed
- Ethnographic studies have shown that work is usually richer and more complex than suggested by simple system models

Requirements validation

- Concerned with demonstrating that the requirements define the system that the customer really wants
- Requirements error costs are high so validation is very important
 - Fixing a requirements error after delivery may cost up to 100 times the cost of fixing an implementation error
- Requirements checking
 - Validity
 - Consistency
 - Completeness
 - Realism
 - Verifiability

Requirements validation techniques

- Reviews
 - Systematic manual analysis of the requirements
- Prototyping
 - Using an executable model of the system to check requirements.
- Test-case generation
 - Developing tests for requirements to check testability
- Automated consistency analysis
 - Checking the consistency of a structured requirements description

Requirements management

- Requirements management is the process of managing changing requirements during the requirements engineering process and system development
- Requirements are inevitably incomplete and inconsistent
 - New requirements emerge during the process as business needs change and a better understanding of the system is developed
 - Different viewpoints have different requirements and these are often contradictory

Software prototyping

Incomplete versions of the software program being developed. Prototyping can also be used by end users to describe and prove requirements that developers have not considered

Benefits:

The software designer and implementer can obtain feedback from the users early in the project. The client and the contractor can compare if the software made matches the software specification, according to which the software program is built.

It also allows the software engineer some insight into the accuracy of initial project estimates and whether the deadlines and milestones proposed can be successfully met.

Process of prototyping

1. Identify basic requirements

Determine basic requirements including the input and output information desired. Details, such as security, can typically be ignored.

2. Develop Initial Prototype

The initial prototype is developed that includes only user interfaces. (See Horizontal Prototype, below)

3. Review

The customers, including end-users, examine the prototype and provide feedback on additions or changes.

4. Revise and Enhance the Prototype

Using the feedback both the specifications and the prototype can be improved. Negotiation about what is within the scope of the contract/product may be necessary. If changes are introduced then a repeat of steps #3 and #4 may be needed.

Dimensions of prototypes

1. Horizontal Prototype

It provides a broad view of an entire system or subsystem, focusing on user interaction more than low-level system functionality, such as database access. Horizontal prototypes are useful for:

- Confirmation of user interface requirements and system scope
- Develop preliminary estimates of development time, cost and effort.

2 Vertical Prototypes

A vertical prototype is a more complete elaboration of a single subsystem or function. It is useful for obtaining detailed requirements for a given function, with the following benefits:

- Refinement database design
- Obtain information on data volumes and system interface needs, for network sizing and performance engineering

Types of prototyping

Software prototyping has many variants. However, all the methods are in some way based on two major types of prototyping: Throwaway Prototyping and Evolutionary Prototyping.

1. Throwaway prototyping

Also called close ended prototyping. Throwaway refers to the creation of a model that will eventually be discarded rather than becoming part of the final delivered software. After preliminary requirements gathering is accomplished, a simple working model of the system is constructed to visually show the users what their requirements may look like when they are implemented into a finished system.

The most obvious reason for using Throwaway Prototyping is that it can be done quickly. If the users can get quick feedback on their requirements, they may be able to refine them early in the development of the software. Making changes early in the development lifecycle is extremely cost effective since there is nothing at that point to redo. If a project is changed after a considerable work has been done then small changes could require large efforts to implement since software systems have many dependencies. Speed is crucial in implementing a throwaway prototype, since with a limited budget of time and money little can be expended on a prototype that will be discarded.

Strength of Throwaway Prototyping is its ability to construct interfaces that the users can test. The user interface is what the user sees as the system, and by seeing it in front of them, it is much easier to grasp how the system will work.

2. Evolutionary prototyping

Evolutionary Prototyping (also known as breadboard prototyping) is quite different from Throwaway Prototyping. The main goal when using Evolutionary Prototyping is to build a very robust prototype in a structured manner and constantly refine it. "The reason for this is that the Evolutionary prototype, when built, forms the heart of the new system, and the improvements and further requirements will be built.

Evolutionary Prototypes have an advantage over Throwaway Prototypes in that they are functional systems. Although they may not have all the features the users have planned, they may be used on a temporary basis until the final system is delivered.

In Evolutionary Prototyping, developers can focus themselves to develop parts of the system that they understand instead of working on developing a whole system. To minimize risk, the developer does not implement poorly understood features. The partial system is sent to customer sites. As users work with the system, they detect opportunities for new features and give requests for these features to developers. Developers then take these enhancement requests along with their own and use sound configuration-management practices to change the software-requirements specification, update the design, recode and retest.

3. Incremental prototyping

The final product is built as separate prototypes. At the end the separate prototypes are merged in an overall design.

4. Extreme prototyping

Extreme Prototyping as a development process is used especially for developing web applications. Basically, it breaks down web development into three phases, each one based on the preceding one. The first phase is a static prototype that consists mainly of HTML pages. In the second phase, the screens are programmed and fully functional using a simulated services layer. In the third phase the services are implemented. The process is called Extreme Prototyping to draw attention to the second phase of the process, where a fully-functional UI is developed with very little regard to the services other than their contract.

Advantages of prototyping

1. Reduced time and costs: Prototyping can improve the quality of requirements and specifications provided to developers. Because changes cost exponentially more to implement as they are detected later in development, the early determination of what the user really wants can result in faster and less expensive software.

2. Improved and increased user involvement: Prototyping requires user involvement and allows them to see and interact with a prototype allowing them to provide better and more complete feedback and specifications. The presence of the prototype being examined by the user prevents many misunderstandings and miscommunications that occur when each side believe the other understands what they said. Since users know the problem domain better than anyone on the development team does, increased interaction can result in final product that has greater tangible and intangible quality. The final product is more likely to satisfy the users' desire for look, feel and performance.

Disadvantages of prototyping

1. Insufficient analysis: The focus on a limited prototype can distract developers from properly analyzing the complete project. This can lead to overlooking better solutions, preparation of incomplete specifications or the conversion of limited prototypes into poorly engineered final projects that are hard to maintain. Further, since a prototype is limited in functionality it may not scale well if the prototype is used as the basis of a final deliverable, which may not be noticed if developers are too focused on building a prototype as a model.

2. User confusion of prototype and finished system: Users can begin to think that a prototype, intended to be thrown away, is actually a final system that merely needs to be finished or polished. (They are, for example, often unaware of the effort needed to add error-checking and security features which a prototype may not have.) This can lead them to expect the prototype to accurately model the performance of the final system when this is not the intent of the developers. Users can also become attached to features that were included in a prototype for consideration and then removed from the specification for a final system. If users are able to require all proposed features be included in the final system this can lead to conflict.

3. Developer misunderstanding of user objectives: Developers may assume that users share their objectives (e.g. to deliver core functionality on time and within budget), without understanding wider commercial issues. For example, user representatives attending Enterprise software (e.g. PeopleSoft) events may have seen demonstrations of "transaction auditing" (where changes are logged and displayed in a difference grid view) without being told that this feature demands additional coding and often requires more hardware to handle extra database accesses. Users might believe they can demand auditing on every field, whereas developers might think this is feature creep because they have made assumptions about the extent of user requirements. If the developer has committed delivery before the user requirements were reviewed, developers are between a rock and a hard place, particularly if user management derives some advantage from their failure to implement requirements.

4. Developer attachment to prototype: Developers can also become attached to prototypes they have spent a great deal of effort producing; this can lead to problems like attempting to convert a limited prototype into a final system when it does not have an appropriate underlying architecture. (This may suggest that throwaway prototyping, rather than evolutionary prototyping, should be used.)

5. Excessive development time of the prototype: A key property to prototyping is the fact that it is supposed to be done quickly. If the developers lose sight of this fact, they very well may try to develop a prototype that is too complex. When the prototype is thrown away the precisely developed requirements that it provides may not yield a sufficient increase in productivity to make up for the time spent developing the prototype. Users can become stuck in debates over details of the prototype, holding up the development team and delaying the final product.

6. Expense of implementing prototyping: the start up costs for building a development team focused on prototyping may be high. Many companies have development methodologies in place, and changing them can mean retraining, retooling, or both. Many companies tend to just jump into the prototyping without bothering to retrain their workers as much as they should. A common problem with adopting prototyping technology is high expectations for productivity with insufficient effort behind the learning curve. In addition to training for the use of a prototyping technique, there is an often overlooked need for developing corporate and project

specific underlying structure to support the technology. When this underlying structure is omitted, lower productivity can often result.

Best projects to use prototyping

It has been found that prototyping is very effective in the analysis and design of on-line systems, especially for transaction processing, where the use of screen dialogs is much more in evidence. The greater the interaction between the computer and the user, the greater the benefit is that can be obtained from building a quick system and letting the user play with it.

Systems with little user interaction, such as batch processing or systems that mostly do calculations, benefit little from prototyping. Sometimes, the coding needed to perform the system functions may be too intensive and the potential gains that prototyping could provide are too small.

Prototyping is especially good for designing good human-computer interfaces. "One of the most productive uses of rapid prototyping to date has been as a tool for iterative user requirements engineering and human-computer interface design.

Methods

There are few formal prototyping methodologies even though most Agile Methods rely heavily upon prototyping techniques.

1. Dynamic systems development method

Dynamic Systems Development Method (DSDM) is a framework for delivering business solutions that relies heavily upon prototyping as a core technique, and is itself ISO 9001 approved. It expands upon most understood definitions of a prototype. According to DSDM the prototype may be a diagram, a business process, or even a system placed into production. DSDM prototypes are intended to be incremental, evolving from simple forms into more comprehensive ones.

DSDM prototypes may be throwaway or evolutionary. Evolutionary prototypes may be evolved horizontally (breadth then depth) or vertically (each section is built in detail with additional iterations detailing subsequent sections). Evolutionary prototypes can eventually evolve into final systems.

The four categories of prototypes as recommended by DSDM are:

- **Business prototypes** – used to design and demonstrate the business processes being automated.
- **Usability prototypes** – used to define, refine, and demonstrate user interface design usability, accessibility, look and feel.
- **Performance and capacity prototypes** - used to define, demonstrate, and predict how systems will perform under peak loads as well as to demonstrate and evaluate other non-functional aspects of the system (transaction rates, data storage volume, response time)
- **Capability/technique prototypes** – used to develop, demonstrate, and evaluate a design approach or concept.

The DSDM lifecycle of a prototype is to:

1. Identify prototype
2. Agree to a plan
3. Create the prototype
4. Review the prototype

2. Operational prototyping

Operational Prototyping was proposed by Alan Davis as a way to integrate throwaway and evolutionary prototyping with conventional system development. "[It] offers the best of both the quick-and-dirty and conventional-development worlds in a sensible manner. Designers develop only well-understood features in building the evolutionary baseline, while using throwaway prototyping to experiment with the poorly understood features."

Davis' belief is that to try to "retrofit quality onto a rapid prototype" is not the correct approach when trying to combine the two approaches. His idea is to engage in an evolutionary prototyping methodology and rapidly prototype the features of the system after each evolution.

The specific methodology follows these steps:

- An evolutionary prototype is constructed and made into a baseline using conventional development strategies, specifying and implementing only the requirements that are well understood.
- Copies of the baseline are sent to multiple customer sites along with a trained prototyper.
- At each site, the prototyper watches the user at the system.
- Whenever the user encounters a problem or thinks of a new feature or requirement, the prototyper logs it. This frees the user from having to record the problem, and allows them to continue working.
- After the user session is over, the prototyper constructs a throwaway prototype on top of the baseline system.
- The user now uses the new system and evaluates. If the new changes aren't effective, the prototyper removes them.
- If the user likes the changes, the prototyper writes feature-enhancement requests and forwards them to the development team.
- The development team, with the change requests in hand from all the sites, then produce a new evolutionary prototype using conventional methods.

Obviously, a key to this method is to have well trained prototypers available to go to the user sites. The Operational Prototyping methodology has many benefits in systems that are complex and have few known requirements in advance.

3. Evolutionary systems development

Evolutionary Systems Development is a class of methodologies that attempt to formally implement Evolutionary Prototyping. One particular type, called Systems craft is described by John Crinnion in his book: Evolutionary Systems Development.

Systemscraft was designed as a 'prototype' methodology that should be modified and adapted to fit the specific environment in which it was implemented.

Systemscraft was not designed as a rigid 'cookbook' approach to the development process. It is now generally recognised[sic] that a good methodology should be flexible enough to be adjustable to suit all kinds of environment and situation...

The basis of Systemscraft, not unlike Evolutionary Prototyping, is to create a working system from the initial requirements and build upon it in a series of revisions. Systemscraft places heavy emphasis on traditional analysis being used throughout the development of the system.

4. Evolutionary rapid development

Evolutionary Rapid Development (ERD) was developed by the Software Productivity Consortium, a technology development and integration agent for the Information Technology Office of the Defense Advanced Research Projects Agency (DARPA).

Fundamental to ERD is the concept of composing software systems based on the reuse of components, the use of software templates and on an architectural template. Continuous evolution of system capabilities in rapid response to changing user needs and technology is highlighted by the evolvable architecture, representing a class of solutions. The process focuses on the use of small artisan-based teams integrating software and systems engineering disciplines working multiple, often parallel short-duration timeboxes with frequent customer interaction.

Key to the success of the ERD-based projects is parallel exploratory analysis and development of features, infrastructures, and components with and adoption of leading edge technologies enabling the quick reaction to changes in technologies, the marketplace, or customer requirements.

To elicit customer/user input, frequent scheduled and ad hoc/impromptu meetings with the stakeholders are held. Demonstrations of system capabilities are held to solicit feedback before design/implementation decisions are solidified. Frequent releases (e.g., betas) are made available for use to provide insight into how the system could better support user and customer needs. This assures that the system evolves to satisfy existing user needs.

The design framework for the system is based on using existing published or de facto standards. The system is organized to allow for evolving a set of capabilities that includes considerations for performance, capacities, and functionality. The architecture is defined in terms of abstract interfaces that encapsulate the services and their implementation (e.g., COTS applications). The architecture serves as a template to be used for guiding development of more than a single instance of the system. It allows for multiple application components to be used to implement the services. A core set of functionality not likely to change is also identified and established.

The ERD process is structured to use demonstrated functionality rather than paper products as a way for stakeholders to communicate their needs and expectations. Central to this goal of rapid delivery is the use of the "time box" method. Timeboxes are fixed periods of time in which specific tasks (e.g., developing a set of functionality) must be performed. Rather than allowing time to expand to satisfy some vague set of goals, the time is fixed (both in terms of calendar weeks and person-hours) and a set of goals is defined that realistically can be achieved within these constraints. To keep development from degenerating into a "random walk," long-range plans are defined to guide the iterations. These plans provide a vision for the overall system and set boundaries (e.g., constraints) for the project. Each iteration within the process is conducted in the context of these long-range plans.

Once architecture is established, software is integrated and tested on a daily basis. This allows the team to assess progress objectively and identify potential problems quickly. Since small amounts of the system are integrated at one time, diagnosing and removing the defect is rapid. User demonstrations can be held at short notice since the system is generally ready to exercise at all times.

5. Scrum

Scrum is an agile method for project management. The approach was first described by Takeuchi and Nonaka in "The New New Product Development Game" (Harvard Business Review, Jan-Feb 1986).

Tools

Efficiently using prototyping requires that an organization have proper tools and a staff trained to use those tools. Tools used in prototyping can vary from individual tools like 4th generation programming languages used for rapid prototyping to complex integrated CASE tools. 4th generation programming languages like Visual Basic and ColdFusion are frequently used since they are cheap, well known and relatively easy and fast to use. CASE tools are often developed or selected by the military or large organizations. Users may prototype elements of an application themselves in a spreadsheet.

1. Screen generators, design tools & Software Factories

Commonly used screen generating programs that enable prototypers to show users systems that don't function, but show what the screens may look like. Developing Human Computer Interfaces can sometimes be the critical part of the development effort, since to the users the interface essentially is the system.

Software Factories are Code Generators that allow you to model the domain model and then drag and drop the UI. Also they enable you to run the prototype and use basic database functionality. This approach allows you to explore the domain model and make sure it is in sync with the GUI prototype.

2. Application definition or simulation software

It enables users to rapidly build lightweight, animated simulations of another computer program, without writing code. Application simulation software allows both technical and non-technical users to experience, test, collaborate and validate the simulated program, and provides reports such as annotations, screenshot and schematics. To simulate applications one can also use software which simulate real-world software programs for computer based training, demonstration, and customer support, such as screen casting software as those areas are closely related.

3. Sketchflow

Sketch Flow, a feature of Microsoft Expression Studio Ultimate, gives the ability to quickly and effectively map out and iterate the flow of an application UI, the layout of individual screens and transition from one application state to another.

- Interactive Visual Tool
- Easy to learn
- Dynamic
- Provides environment to collect feedback

4. Visual Basic

One of the most popular tools for Rapid Prototyping is Visual Basic (VB). Microsoft Access, which includes a Visual Basic extensibility module, is also a widely accepted prototyping tool that is used by many non-technical business analysts. Although VB is a programming language it has many features that facilitate using it to create prototypes, including:

- An interactive/visual user interface design tool.
- Easy connection of user interface components to underlying functional behavior.
- Modifications to the resulting software are easy to perform.

5. Requirements Engineering Environment

It provides an integrated toolset for rapidly representing, building, and executing models of critical aspects of complex systems.

It is currently used by the Air Force to develop systems. It is: an integrated set of tools that allows systems analysts to rapidly build functional, user interface, and performance prototype models of system components. These modeling activities are performed to gain a greater understanding of complex systems and lessen the impact that inaccurate requirement specifications have on cost and scheduling during the system development process.

REE is composed of three parts. The first, called proto is a CASE tool specifically designed to support rapid prototyping. The second part is called the Rapid Interface Prototyping System or RIP, which is a collection of tools that facilitate the creation of user interfaces. The third part of REE is a user interface to RIP and proto that is graphical and intended to be easy to use.

Rome Laboratory, the developer of REE, intended that to support their internal requirements gathering methodology. Their method has three main parts:

- Elicitation from various sources which means u loose (users, interfaces to other systems), specification, and consistency checking
- Analysis that the needs of diverse users taken together do not conflict and are technically and economically feasible
- Validation that requirements so derived are an accurate reflection of user needs.

6. LYMB

LYMB is an object-oriented development environment aimed at developing applications that require combining graphics-based user interfaces, visualization, and rapid prototyping.

7. Non-relational environments

Non-relational definition of data (e.g. using Cache or associative models can help make end-user prototyping more productive by delaying or avoiding the need to normalize data at every iteration of a simulation. This may yield earlier/greater clarity of business requirements, though it does not specifically confirm that requirements are technically and economically feasible in the target production system.

8. PSDL

PSDL is a prototype description language to describe real-time software.

Prototyping in the Software Process

System prototyping

- Prototyping is the rapid development of a system
- In the past, the developed system was normally thought of as inferior in some way to the required system so further development was required
- Now, the boundary between prototyping and normal system development is blurred and many systems are developed using an evolutionary approach

Uses of system prototypes

- The principal use is to help customers and developers understand the requirements for the system
 - Requirements elicitation. Users can experiment with a prototype to see how the system supports their work
 - Requirements validation. The prototype can reveal errors and omissions in the requirements
- Prototyping can be considered as a risk reduction activity which reduces requirements risks

Prototyping benefits

- Misunderstandings between software users and developers are exposed
- Missing services may be detected and confusing services may be identified
- A working system is available early in the process
- The prototype may serve as a basis for deriving a system specification
- The system can support user training and system testing

Prototyping process

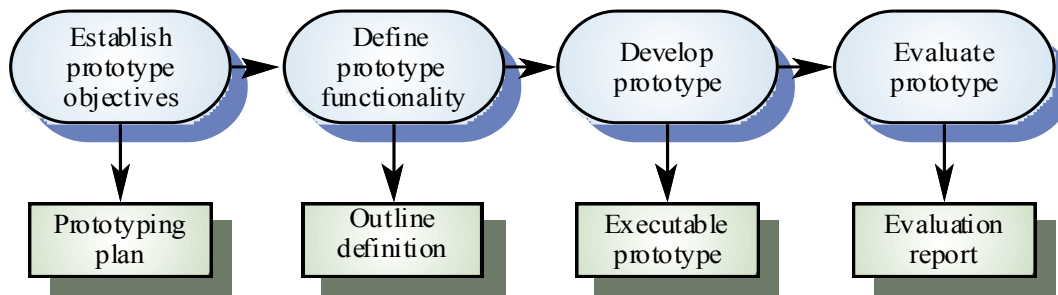

Prototyping in the software process

- **Evolutionary prototyping**
 - An approach to system development where an initial prototype is produced and refined through a number of stages to the final system
- **Throw-away prototyping**
 - A prototype which is usually a practical implementation of the system is produced to help discover requirements problems and then discarded. The system is then developed using some other development process

Data Model

- Used to describe the logical structure of data processed by the system
- Entity-relation-attribute model sets out the entities in the system, the relationships between these entities and the entity attributes
- Widely used in database design. Can readily be implemented using relational databases
- No specific notation provided in the UML but objects and associations can be used

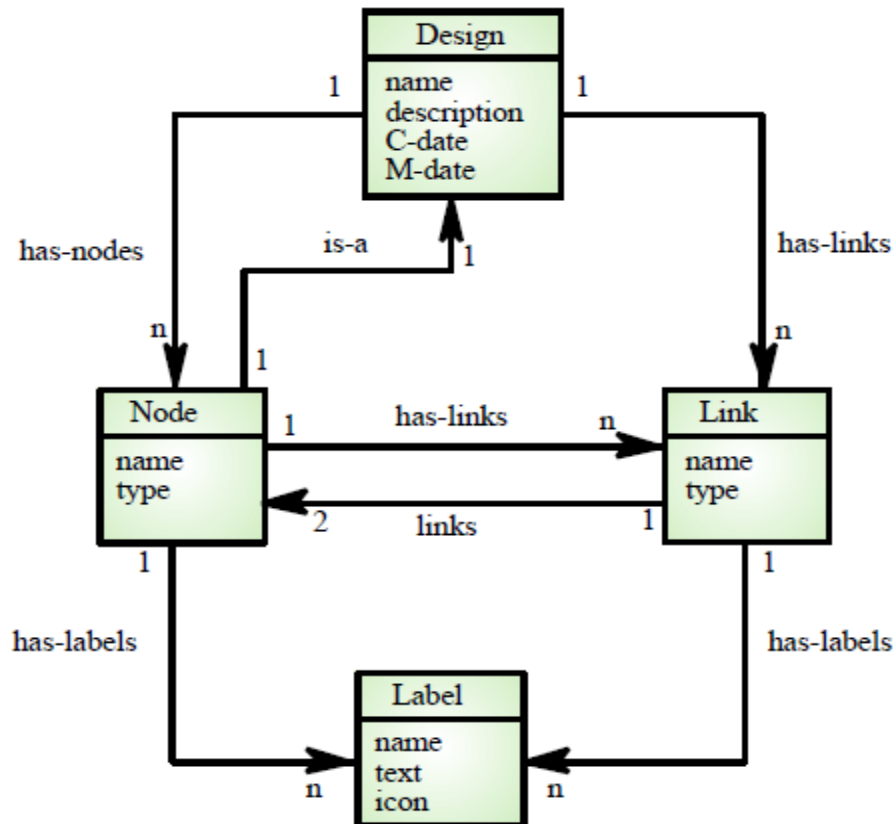

Behavioural Model

- Behavioural models are used to describe the overall behaviour of a system
- Two types of behavioural model are shown here
 - Data processing models that show how data is processed as it moves through the system
 - State machine models that show the systems response to events
- Both of these models are required for a description of the system's behaviour

1. Data-processing models

- Data flow diagrams are used to model the system's data processing
- These show the processing steps as data flows through a system
- Intrinsic part of many analysis methods
- Simple and intuitive notation that customers can understand
- Show end-to-end processing of data

Data flow diagrams

- DFDs model the system from a functional perspective
- Tracking and documenting how the data associated with a process is helpful to develop an overall understanding of the system
- Data flow diagrams may also be used in showing the data exchange between a system and other systems in its environment

Order processing DFD

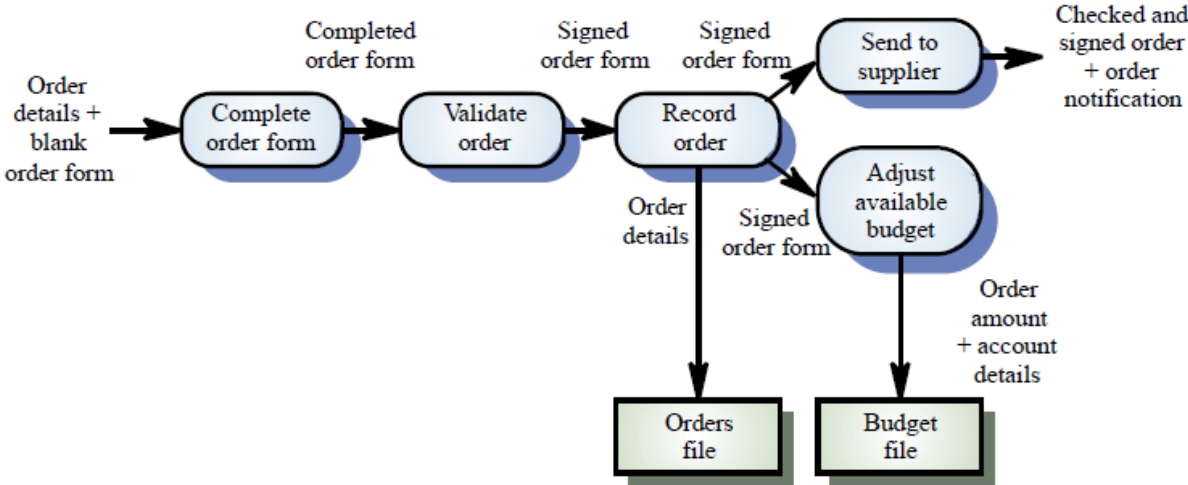

2. State machine models

- These model the behaviour of the system in response to external and internal events
- They show the system’s responses to stimuli so are often used for modelling real-time systems
- State machine models show system states as nodes and events as arcs between these nodes.
- When an event occurs, the system moves from one state to another
- Statecharts are an integral part of the UML

Microwave oven model

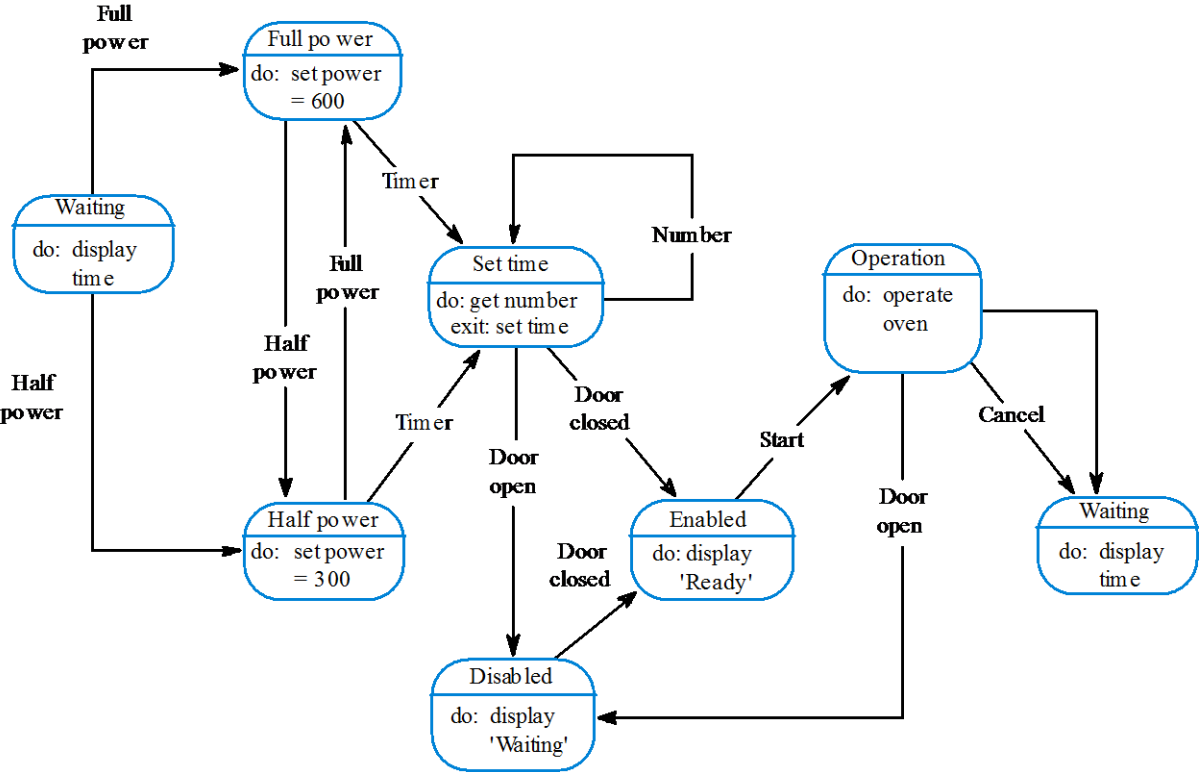

Statecharts

- Allow the decomposition of a model into submodels
- A brief description of the actions is included following the 'do' in each state
- Can be complemented by tables describing the states and the stimuli

Structured Analysis

- The data-flow approach is typified by the Structured Analysis method (SA)
- Two major strategies dominate structured analysis
 - 'Old' method popularised by DeMarco
 - 'Modern' approach by Yourdon

DeMarco

- A top-down approach
 - The analyst maps the current physical system onto the current logical data-flow model
- The approach can be summarised in four steps:
 - Analysis of current physical system
 - Derivation of logical model
 - Derivation of proposed logical model
 - Implementation of new physical system

Modern structured analysis

- Distinguishes between user's real needs and those requirements that represent the external behaviour satisfying those needs
- Includes real-time extensions
- Other structured analysis approaches include:
 - Structured Analysis and Design Technique (SADT)
 - Structured Systems Analysis and Design Methodology (SSADM)

Method weaknesses

- They do not model non-functional system requirements.
- They do not usually include information about whether a method is appropriate for a given problem.
- They may produce too much documentation.
- The system models are sometimes too detailed and difficult for users to understand.

CASE workbenches

- A coherent set of tools that is designed to support related software process activities such as analysis, design or testing.
- Analysis and design workbenches support system modelling during both requirements engineering and system design.
- These workbenches may support a specific design method or may provide support for a creating several different types of system model.

An analysis and design workbench

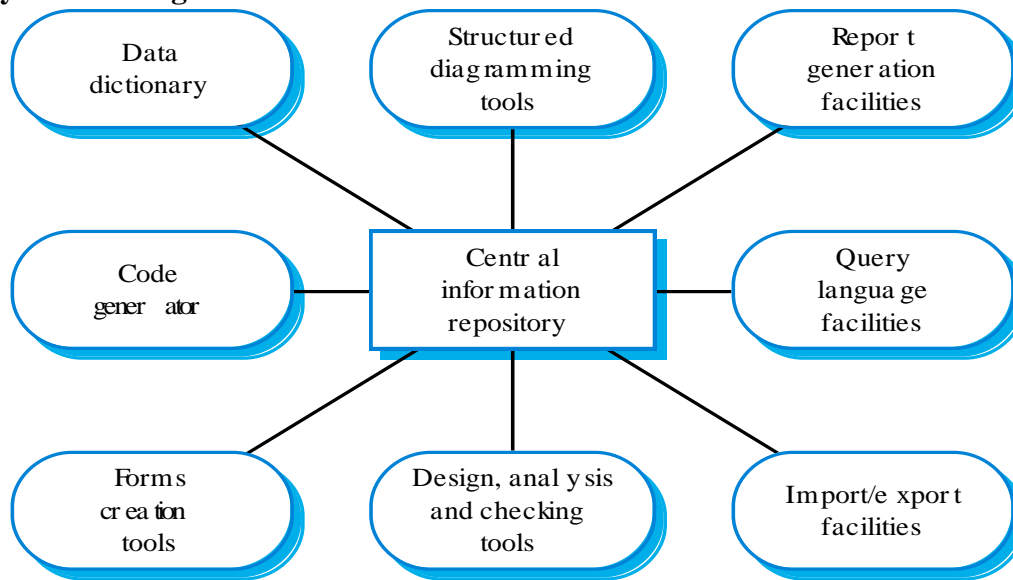

Analysis workbench components

- Diagram editors
- Model analysis and checking tools
- Repository and associated query language
- Data dictionary
- Report definition and generation tools
- Forms definition tools
- Import/export translators
- Code generation tools

Data Dictionary

- Data dictionaries are lists of all of the names used in the system models. Descriptions of the entities, relationships and attributes are also included
- Advantages
 - Support name management and avoid duplication
 - Store of organisational knowledge linking analysis, design and implementation
- Many CASE workbenches support data dictionaries

Data dictionary entries

Name	Description	Type	Date
has-labels	1:N relation between entities of type Node or Link and entities of type Label.	Relation	5.10.1998
Label	Holds structured or unstructured information about nodes or links. Labels are represented by an icon (which can be a transparent box) and associated text.	Entity	8.12.1998
Link	A 1:1 relation between design entities represented as nodes. Links are typed and may be named.	Relation	8.12.1998
name (label)	Each label has a name which identifies the type of label. The name must be unique within the set of label types used in a design.	Attribute	8.12.1998
name (node)	Each node has a name which must be unique within a design. The name may be up to 64 characters long.	Attribute	15.11.1998

UNIT III

ANALYSIS, DESIGN CONCEPTS AND PRINCIPLES

Design Concepts and Principles:

- Map the information from the analysis model to the design representations - data design, architectural design, interface design, procedural design

Analysis to Design:

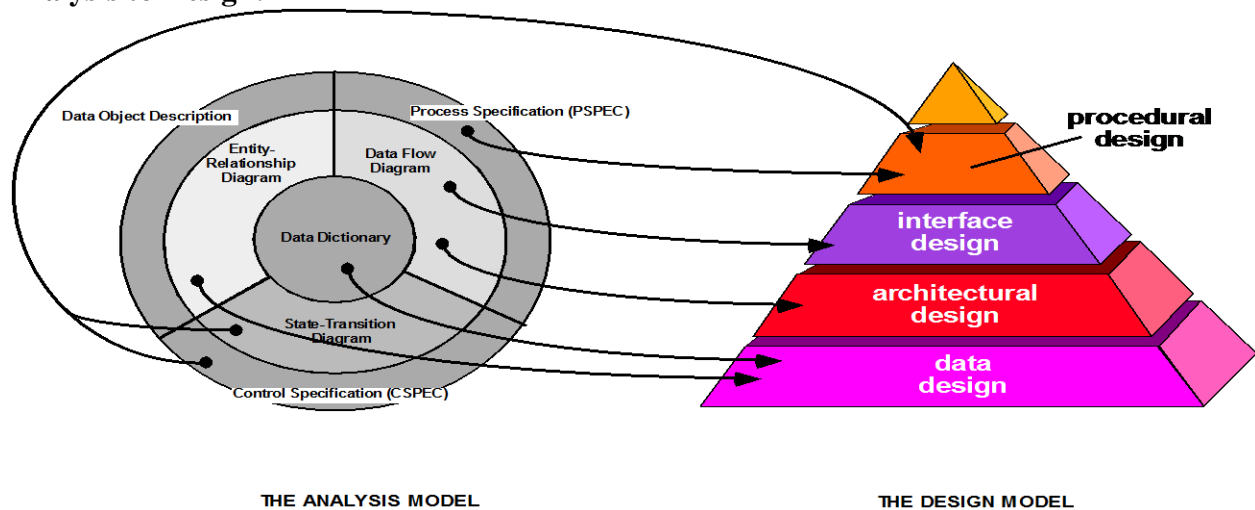

Design Models – 1:

- **Data Design**
 - created by transforming the data dictionary and ERD into implementation data structures
 - requires as much attention as algorithm design
- **Architectural Design**
 - derived from the analysis model and the subsystem interactions defined in the DFD
- **Interface Design**
 - derived from DFD and CFD
 - describes software elements communication with
 - other software elements
 - other systems
 - human users

Design Models – 2 :

- Procedure-level design
 - created by transforming the structural elements defined by the software architecture into procedural descriptions of software components
 - Derived from information in the PSPEC, CSPEC, and STD

Design Principles – 1:

- Process should not suffer from tunnel vision – consider alternative approaches
- Design should be traceable to analysis model
- Do not try to reinvent the wheel
- use design patterns ie reusable components
- Design should exhibit both uniformity and integration
- Should be structured to accommodate changes

Design Principles – 2 :

- Design is not coding and coding is not design
- Should be structured to degrade gently, when bad data, events, or operating conditions are encountered
- Needs to be assessed for quality as it is being created
- Needs to be reviewed to minimize conceptual (semantic) errors

Design Concepts -1 :

- Abstraction
 - allows designers to focus on solving a problem without being concerned about irrelevant lower level details

Procedural abstraction is a named sequence of instructions that has a specific and limited function

e.g open a door

Open implies a long sequence of procedural steps

data abstraction is collection of data that describes a data object

e.g door type, opening mech, weight, dimen

Design Concepts -2 :

- Design Patterns
 - description of a design structure that solves a particular design problem within a specific context and its impact when applied

Design Concepts -3 :

- Software Architecture
 - overall structure of the software components and the ways in which that structure
 - provides conceptual integrity for a system

Design Concepts -4 :

- Information Hiding
 - information (data and procedure) contained within a module is inaccessible to modules that have no need for such information
- Functional Independence
 - achieved by developing modules with single-minded purpose and an aversion to excessive interaction with other models

Refactoring – Design concepts :

- Fowler [FOW99] defines refactoring in the following manner:
 - "Refactoring is the process of changing a software system in such a way that it does not alter the external behavior of the code [design] yet improves its internal structure."
- When software is refactored, the existing design is examined for
 - redundancy
 - unused design elements
 - inefficient or unnecessary algorithms
 - poorly constructed or inappropriate data structures
 - or any other design failure that can be corrected to yield a better design.

Design Concepts – 4 :

- Objects
 - encapsulate both data and data manipulation procedures needed to describe the content and behavior of a real world entity
- Class
 - generalized description (template or pattern) that describes a collection of similar objects
- Inheritance
 - provides a means for allowing subclasses to reuse existing superclass data and procedures; also provides mechanism for propagating changes

Design Concepts – 5:

- Messages
 - the means by which objects exchange information with one another
- Polymorphism
 - a mechanism that allows several objects in a class hierarchy to have different methods with the same name
 - instances of each subclass will be free to respond to messages by calling their own version of the method

Modular Design Methodology Evaluation – 1:**Modularity**

- the degree to which software can be understood by examining its components independently of one another
- Modular decomposability
 - provides systematic means for breaking problem into sub problems

- Modular compos ability
 - supports reuse of existing modules in new systems
- Modular understandability
 - module can be understood as a stand-alone unit

Modular Design Methodology Evaluation – 2:

- Modular continuity
 - module change side-effects minimized
- Modular protection
 - processing error side-effects minimized

Effective Modular Design:

- Functional independence
 - modules have high cohesion and low coupling
- Cohesion
 - qualitative indication of the degree to which a module focuses on just one thing
- Coupling
 - qualitative indication of the degree to which a module is connected to other modules and to the outside world

Architectural Design:

Why Architecture?

The architecture is not the operational software. Rather, it is a representation that enables a software engineer to:

- (1) analyze the effectiveness of the design in meeting its stated requirements,
- (2) consider architectural alternatives at a stage when making design changes is still relatively easy, and
- (3) reduce the risks associated with the construction of the software.

Importance :

- Software architecture representations enable communications among stakeholders
- Architecture highlights early design decisions that will have a profound impact on the ultimate success of the system as an operational entity
- The architecture constitutes an intellectually graspable model of how the system is structured and how its components work together

Architectural Styles – 1:

- Data centered
 - file or database lies at the center of this architecture and is accessed frequently by other components that modify data

Architectural Styles – 2:

- Data flow
 - input data is transformed by a series of computational components into output data
 - Pipe and filter pattern has a set of components called filters, connected by pipes that transmit data from one component to the next.
 - If the data flow degenerates into a single line of transforms, it is termed batch sequential
- Object-oriented
 - components of system encapsulate data and operations, communication between components is by message passing

- Layered
 - several layers are defined
 - each layer performs operations that become closer to the machine instruction set in the lower layers

Architectural Styles – 3:**Call and return**

- program structure decomposes function into control hierarchy with main program invoking several subprograms

Software Architecture Design – 1:

- Software to be developed must be put into context
 - model external entities and define interfaces
- Identify architectural archetypes
 - collection of abstractions that must be modeled if the system is to be constructed

Object oriented Architecture :

- The components of a system encapsulate data and the operations that must be applied to manipulate the data. Communication and coordination between components is accomplished via message passing

Software Architecture Design – 2:

- Specify structure of the system
 - define and refine the software components needed to implement each archetype
- Continue the process iteratively until a complete architectural structure has been derived

Layered Architecture:

- Number of different layers are defined, each accomplishing operations that progressively become closer to the machine instruction set
- At the outer layer – components service user interface operations.
- At the inner layer – components perform operating system interfacing.
- Intermediate layers provide utility services and application software function

Architecture Tradeoff Analysis – 1:

1. Collect scenarios
2. Elicit requirements, constraints, and environmental description
3. Describe architectural styles/patterns chosen to address scenarios and requirements
 - module view
 - process view
 - data flow view

Architecture Tradeoff Analysis – 2:

4. Evaluate quality attributes independently (e.g. reliability, performance, security, maintainability, flexibility, testability, portability, reusability, interoperability)
5. Identify sensitivity points for architecture
 - any attributes significantly affected by changing in the architecture

Refining Architectural Design:

- Processing narrative developed for each module
- Interface description provided for each module
- Local and global data structures are defined
- Design restrictions/limitations noted
- Design reviews conducted

- Refinement considered if required and justified

Architectural Design

- An early stage of the system design process.
- Represents the link between specification and design processes.
- Often carried out in parallel with some specification activities.
- It involves identifying major system components and their communications.

Advantages of explicit architecture

- Stakeholder communication
 - Architecture may be used as a focus of discussion by system stakeholders.
- System analysis
 - Means that analysis of whether the system can meet its non-functional requirements is possible.
- Large-scale reuse
 - The architecture may be reusable across a range of systems.

Architecture and system characteristics

- Performance
 - Localise critical operations and minimise communications. Use large rather than fine-grain components.
- Security
 - Use a layered architecture with critical assets in the inner layers.
- Safety
 - Localise safety-critical features in a small number of sub-systems.
- Availability
 - Include redundant components and mechanisms for fault tolerance.
- Maintainability
 - Use fine-grain, replaceable components.

Architectural conflicts

- Using large-grain components improves performance but reduces maintainability.
- Introducing redundant data improves availability but makes security more difficult.
- Localising safety-related features usually means more communication so degraded performance.

System structuring

- Concerned with decomposing the system into interacting sub-systems.
- The architectural design is normally expressed as a block diagram presenting an overview of the system structure.
- More specific models showing how sub-systems share data, are distributed and interface with each other may also be developed.

Packing robot control system

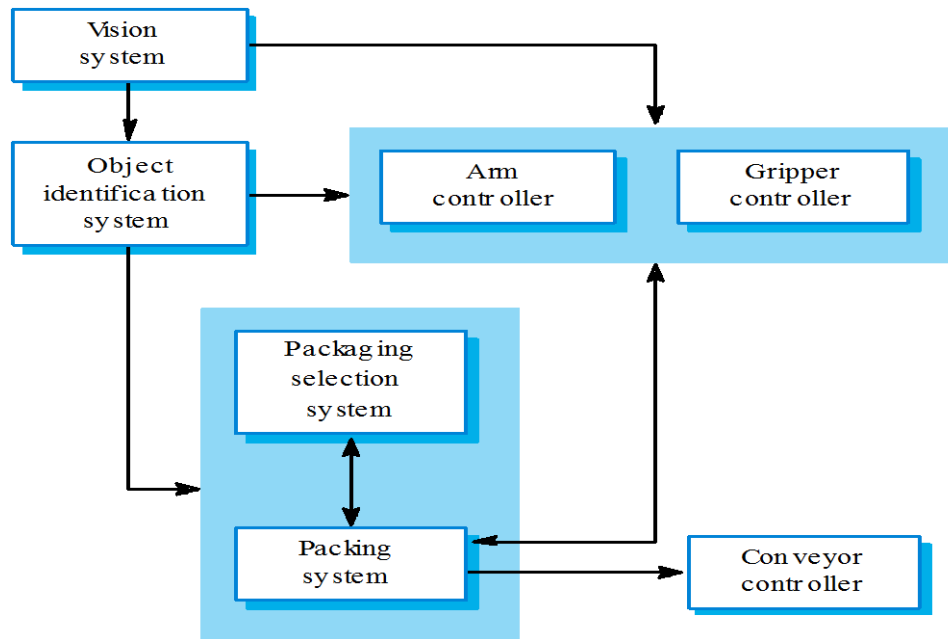

Box and line diagrams

- Very abstract - they do not show the nature of component relationships nor the externally visible properties of the sub-systems.
- However, useful for communication with stakeholders and for project planning.

Architectural design decisions

- Architectural design is a creative process so the process differs depending on the type of system being developed.
- However, a number of common decisions span all design processes.
- Is there a generic application architecture that can be used?
- How will the system be distributed?
- What architectural styles are appropriate?
- What approach will be used to structure the system?
- How will the system be decomposed into modules?
- What control strategy should be used?
- How will the architectural design be evaluated?
- How should the architecture be documented?

Architecture reuse

- Systems in the same domain often have similar architectures that reflect domain concepts.
- Application product lines are built around a core architecture with variants that satisfy particular customer requirements.

Architectural styles

- The architectural model of a system may conform to a generic architectural model or style.
- An awareness of these styles can simplify the problem of defining system architectures.
- However, most large systems are heterogeneous and do not follow a single architectural style.

Architectural models

- Used to document an architectural design.

- Static structural model that shows the major system components.
- Dynamic process model that shows the process structure of the system.
- Interface model that defines sub-system interfaces.
- Relationships model such as a data-flow model that shows sub-system relationships.
- Distribution model that shows how sub-systems are distributed across computers.

System organisation

- Reflects the basic strategy that is used to structure a system.
- Three organisational styles are widely used:
 - A shared data repository style;
 - A shared services and servers style;
 - An abstract machine or layered style.

The repository model

- Sub-systems must exchange data. This may be done in two ways:
 - Shared data is held in a central database or repository and may be accessed by all sub-systems;
 - Each sub-system maintains its own database and passes data explicitly to other sub-systems.
- When large amounts of data are to be shared, the repository model of sharing is most commonly used.

CASE toolset architecture

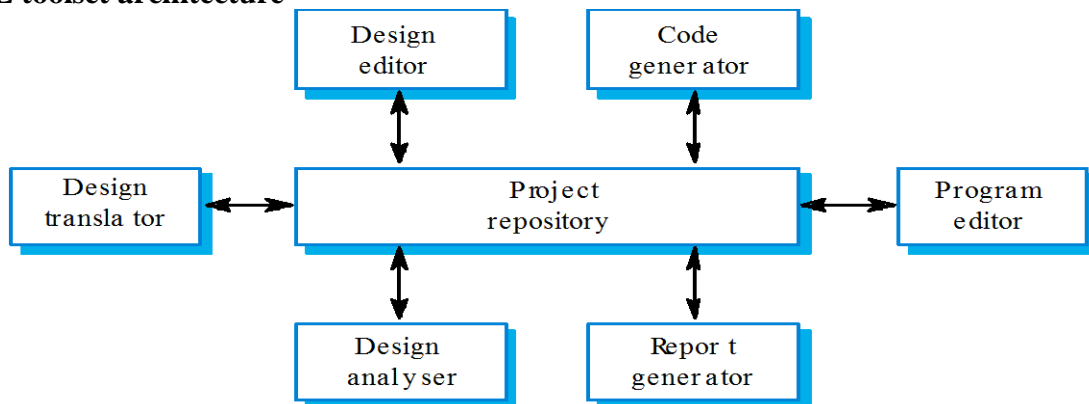

Repository model characteristics

Advantages

- Efficient way to share large amounts of data;
- Sub-systems need not be concerned with how data is produced Centralised management e.g. backup, security, etc.
- Sharing model is published as the repository schema.

Disadvantages

- Sub-systems must agree on a repository data model. Inevitably a compromise;
- Data evolution is difficult and expensive;
- No scope for specific management policies;
- Difficult to distribute efficiently.

Client-server model

- Distributed system model which shows how data and processing is distributed across a range of components.
- Set of stand-alone servers which provide specific services such as printing, data management, etc.
- Set of clients which call on these services.
- Network which allows clients to access servers.

Client-server characteristics

Advantages

- Distribution of data is straightforward;
- Makes effective use of networked systems. May require cheaper hardware;
- Easy to add new servers or upgrade existing servers.

Disadvantages

- No shared data model so sub-systems use different data organisation. Data interchange may be inefficient;
- Redundant management in each server;
- No central register of names and services - it may be hard to find out what servers and services are available.

Abstract machine (layered) model

- Used to model the interfacing of sub-systems.
- Organises the system into a set of layers (or abstract machines) each of which provide a set of services.
- Supports the incremental development of sub-systems in different layers. When a layer interface changes, only the adjacent layer is affected.
- However, often artificial to structure systems in this way.

Modular decomposition styles

- Styles of decomposing sub-systems into modules.
- No rigid distinction between system organisation and modular decomposition.

Sub-systems and modules

- A sub-system is a system in its own right whose operation is independent of the services provided by other sub-systems.
- A module is a system component that provides services to other components but would not normally be considered as a separate system.
- Modular decomposition
- Another structural level where sub-systems are decomposed into modules.
- Two modular decomposition models covered
 - An object model where the system is decomposed into interacting object;
 - A pipeline or data-flow model where the system is decomposed into functional modules which transform inputs to outputs.
- If possible, decisions about concurrency should be delayed until modules are implemented.

Object models

- Structure the system into a set of loosely coupled objects with well-defined interfaces.
- Object-oriented decomposition is concerned with identifying object classes, their attributes and operations.
- When implemented, objects are created from these classes and some control model used to coordinate object operations.

Invoice processing system

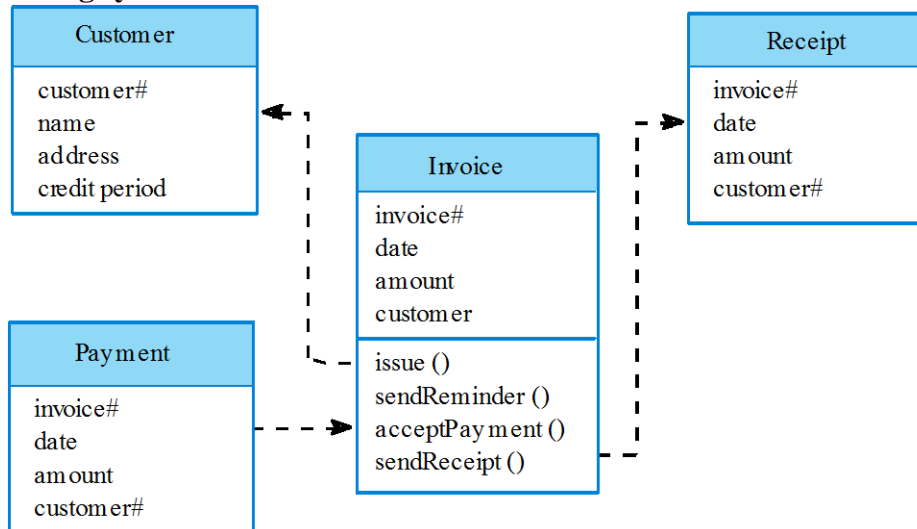

Object model advantages

- Objects are loosely coupled so their implementation can be modified without affecting other objects.
- The objects may reflect real-world entities.
- OO implementation languages are widely used.
- However, object interface changes may cause problems and complex entities may be hard to represent as objects.

Function-oriented pipelining

- Functional transformations process their inputs to produce outputs.
- May be referred to as a pipe and filter model (as in UNIX shell).
- Variants of this approach are very common. When transformations are sequential, this is a batch sequential model which is extensively used in data processing systems.
- Not really suitable for interactive systems.

User interface design

- Designing effective interfaces for software systems
- System users often judge a system by its interface rather than its functionality
- A poorly designed interface can cause a user to make catastrophic errors
- Poor user interface design is the reason why so many software systems are never used
- Most users of business systems interact with these systems through graphical user interfaces (GUIs)
- In some cases, legacy text-based interfaces are still used

User interface design process

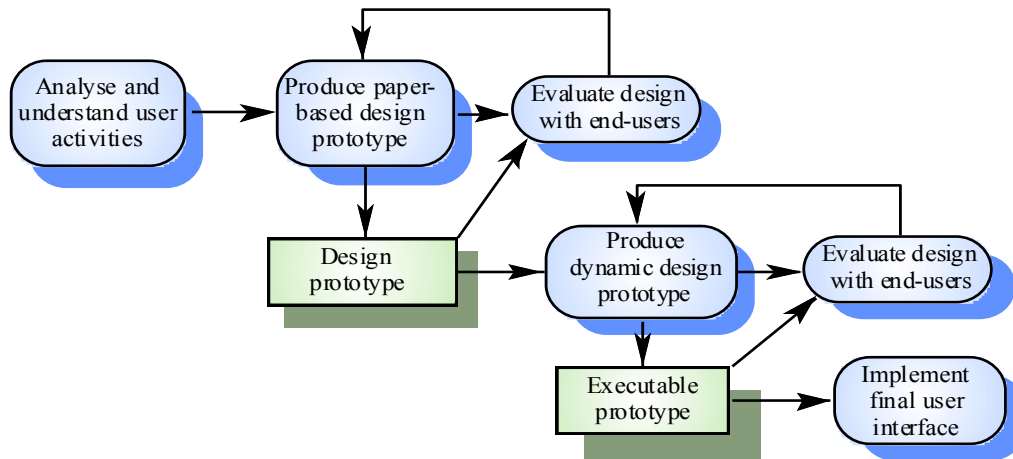

UI design principles

- User familiarity
 - The interface should be based on user-oriented terms and concepts rather than computer concepts
 - E.g., an office system should use concepts such as letters, documents, folders etc. rather than directories, file identifiers, etc.
- Consistency
 - The system should display an appropriate level of consistency
 - Commands and menus should have the same format, command punctuation should be similar, etc.
- Minimal surprise
 - If a command operates in a known way, the user should be able to predict the operation of comparable commands
- Recoverability
 - The system should provide some interface to user errors and allow the user to recover from errors
- User guidance
 - Some user guidance such as help systems, on-line manuals, etc. should be supplied
- User diversity
 - Interaction facilities for different types of user should be supported
 - E.g., some users have seeing difficulties and so larger text should be available

User-system interaction

- Two problems must be addressed in interactive systems design
 - How should information from the user be provided to the computer system?
 - How should information from the computer system be presented to the user?

Interaction styles

- Direct manipulation
 - Easiest to grasp with immediate feedback
 - Difficult to program
- Menu selection
 - User effort and errors minimized
 - Large numbers and combinations of choices a problem

- Form fill-in
 - Ease of use, simple data entry
 - Tedious, takes a lot of screen space
- Natural language
 - Great for casual users
 - Tedious for expert users

Information presentation

- Information presentation is concerned with presenting system information to system users
- The information may be presented directly or may be transformed in some way for presentation
- The Model-View-Controller approach is a way of supporting multiple presentations of data

Information display

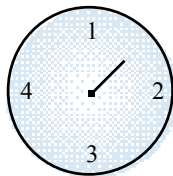

Dial with needle

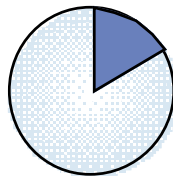

Pie chart

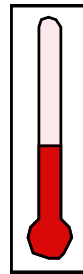

Thermometer



Horizontal bar

Displaying relative values

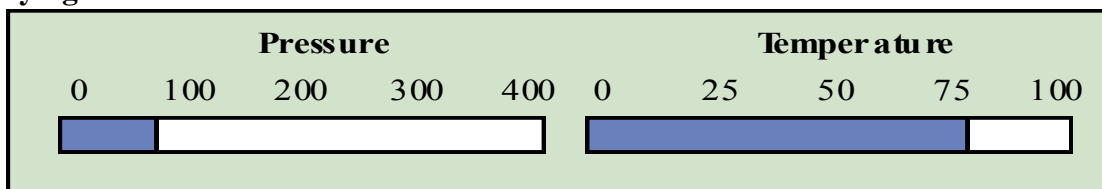

Textual highlighting

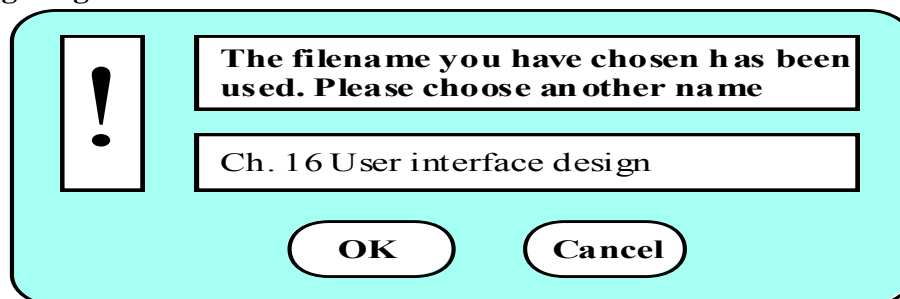

Data visualisation

- Concerned with techniques for displaying large amounts of information

- Visualisation can reveal relationships between entities and trends in the data
- Possible data visualisations are:
 - Weather information
 - State of a telephone network
 - Chemical plant pressures and temperatures
 - A model of a molecule

Colour displays

- Colour adds an extra dimension to an interface and can help the user understand complex information structures
- Can be used to highlight exceptional events
 - The use of colour to communicate meaning

Error messages

- Error message design is critically important. Poor error messages can mean that a user rejects rather than accepts a system
- Messages should be polite, concise, consistent and constructive
- The background and experience of users should be the determining factor in message design

User interface evaluation

- Some evaluation of a user interface design should be carried out to assess its suitability
- Full scale evaluation is very expensive and impractical for most systems
- Ideally, an interface should be evaluated against req
- However, it is rare for such specifications to be produced

Real Time Software Design

- Systems which monitor and control their environment
- Inevitably associated with hardware devices
 - Sensors: Collect data from the system environment
 - Actuators: Change (in some way) the system's environment
- Time is critical. Real-time systems MUST respond within specified times
- A real-time system is a software system where the correct functioning of the system depends on the results produced by the system and the time at which these results are produced
- A 'soft' real-time system is a system whose operation is degraded if results are not produced according to the specified timing requirements
- A 'hard' real-time system is a system whose operation is incorrect if results are not produced according to the timing specification

Stimulus/Response Systems

- Given a stimulus, the system must produce a response within a specified time
- 2 classes
- Periodic stimuli. Stimuli which occur at predictable time intervals
 - For example, a temperature sensor may be polled 10 times per second
- Aperiodic stimuli. Stimuli which occur at unpredictable times
 - For example, a system power failure may trigger an interrupt which must be processed by the system

Architectural considerations

- Because of the need to respond to timing demands made by different stimuli / responses, the system architecture must allow for fast switching between stimulus handlers
- Timing demands of different stimuli are different so a simple sequential loop is not usually adequate

Real –Time Software Design:

- Designing embedded software systems whose behaviour is subject to timing constraints
- To explain the concept of a real-time system and why these systems are usually implemented as concurrent processes
- To describe a design process for real-time systems
- To explain the role of a real-time executive
- To introduce generic architectures for monitoring and control and data acquisition systems

Real-time systems:

- Systems which monitor and control their environment
- Inevitably associated with hardware devices
 - Sensors: Collect data from the system environment
 - Actuators: Change (in some way) the system's environment
- Time is critical. Real-time systems MUST respond within specified times

Definition:

- A real-time system is a software system where the correct functioning of the system depends on the results produced by the system and the time at which these results are produced
- A ‘soft’ real-time system is a system whose operation is degraded if results are not produced according to the specified timing requirements
- A ‘hard’ real-time system is a system whose operation is incorrect if results are not produced according to the timing specification

Stimulus/Response Systems:

- Given a stimulus, the system must produce a response within a specified time
- Periodic stimuli. Stimuli which occur at predictable time intervals
 - For example, a temperature sensor may be polled 10 times per second
- Aperiodic stimuli. Stimuli which occur at unpredictable times
 - For example, a system power failure may trigger an interrupt which must be processed by the system

Architectural considerations:

- Because of the need to respond to timing demands made by different stimuli/responses, the system architecture must allow for fast switching between stimulus handlers
- Timing demands of different stimuli are different so a simple sequential loop is not usually adequate
- Real-time systems are usually designed as cooperating processes with a real-time executive controlling these processes

A real-time system model:

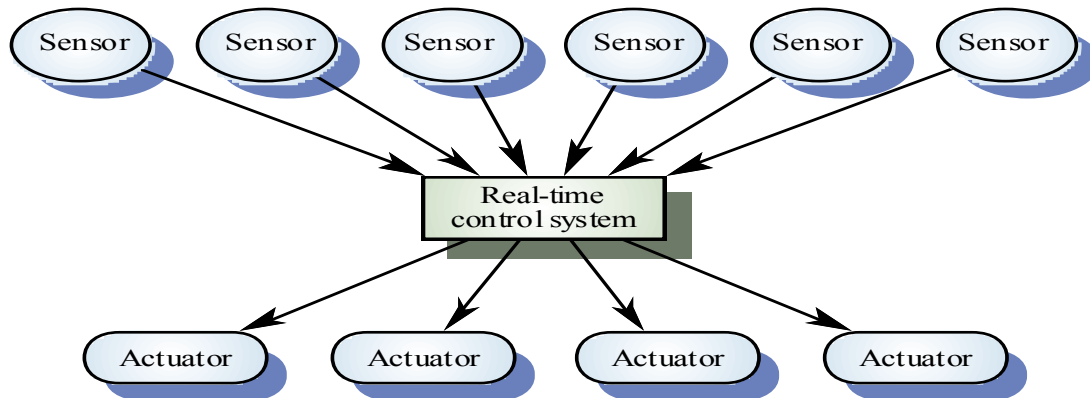
**System elements:**

- Sensors control processes
 - Collect information from sensors. May buffer information collected in response to a sensor stimulus
- Data processor
 - Carries out processing of collected information and computes the system response
- Actuator control
 - Generates control signals for the actuator

R-T systems design process:

- Identify the stimuli to be processed and the required responses to these stimuli
- For each stimulus and response, identify the timing constraints
- Aggregate the stimulus and response processing into concurrent processes. A process may be associated with each class of stimulus and response
- Design algorithms to process each class of stimulus and response. These must meet the given timing requirements
- Design a scheduling system which will ensure that processes are started in time to meet their deadlines
- Integrate using a real-time executive or operating system

Timing constraints:

- May require extensive simulation and experiment to ensure that these are met by the system
- May mean that certain design strategies such as object-oriented design cannot be used because of the additional overhead involved
- May mean that low-level programming language features have to be used for performance reasons

Real-time programming:

- Hard-real time systems may have to be programmed in assembly language to ensure that deadlines are met
- Languages such as C allow efficient programs to be written but do not have constructs to support concurrency or shared resource management
- Ada as a language designed to support real-time systems design so includes a general purpose concurrency mechanism

Non-stop system components:

- Configuration manager
 - Responsible for the dynamic reconfiguration of the system software and hardware. Hardware modules may be replaced and software upgraded without stopping the systems
- Fault manager
 - Responsible for detecting software and hardware faults and taking appropriate actions (e.g. switching to backup disks) to ensure that the system continues in operation

Burglar alarm system e.g

- A system is required to monitor sensors on doors and windows to detect the presence of intruders in a building
- When a sensor indicates a break-in, the system switches on lights around the area and calls police automatically
- The system should include provision for operation without a mains power supply
- Sensors
 - Movement detectors, window sensors, door sensors.
 - 50 window sensors, 30 door sensors and 200 movement detectors
 - Voltage drop sensor
- Actions
 - When an intruder is detected, police are called automatically.
 - Lights are switched on in rooms with active sensors.
 - An audible alarm is switched on.
 - The system switches automatically to backup power when a voltage drop is detected.

The R-T system design process:

- Identify stimuli and associated responses
- Define the timing constraints associated with each stimulus and response
- Allocate system functions to concurrent processes
- Design algorithms for stimulus processing and response generation
- Design a scheduling system which ensures that processes will always be scheduled to meet their deadlines

Control systems:

- A burglar alarm system is primarily a monitoring system. It collects data from sensors but no real-time actuator control
- Control systems are similar but, in response to sensor values, the system sends control signals to actuators
- An example of a monitoring and control system is a system which monitors temperature and switches heaters on and off

Data acquisition systems:

- Collect data from sensors for subsequent processing and analysis.
- Data collection processes and processing processes may have different periods and deadlines.
- Data collection may be faster than processing e.g. collecting information about an explosion.
- Circular or ring buffers are a mechanism for smoothing speed differences.

A temperature control system:

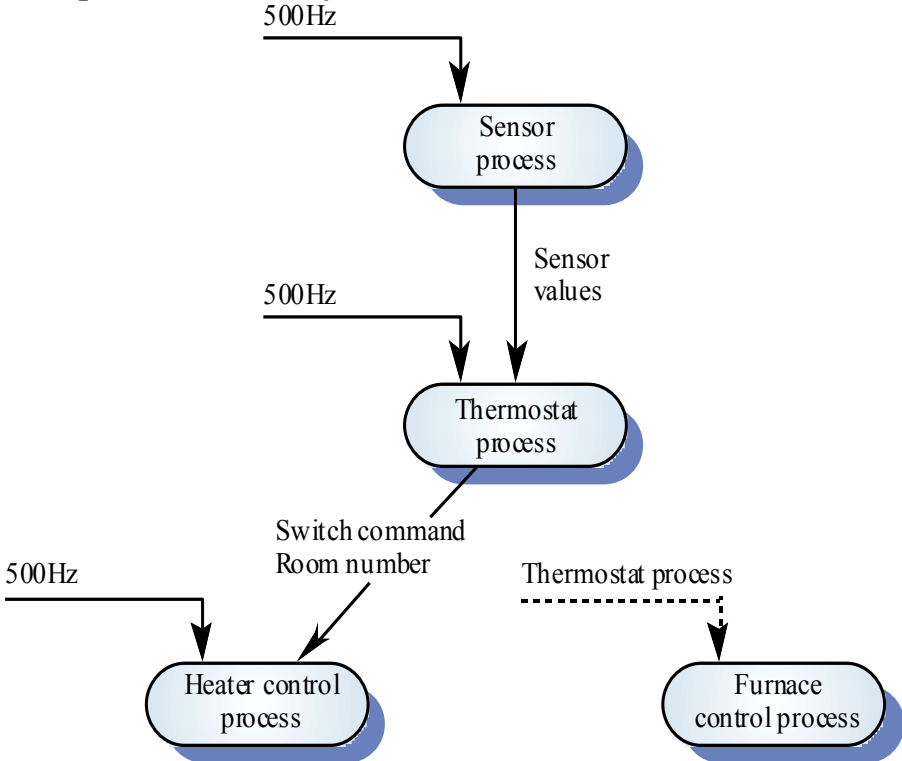

Reactor data collection:

- A system collects data from a set of sensors monitoring the neutron flux from a nuclear reactor.
- Flux data is placed in a ring buffer for later processing.
- The ring buffer is itself implemented as a concurrent process so that the collection and processing processes may be synchronized.

Reactor flux monitoring:

Sensors (each data flow is a sensor value)

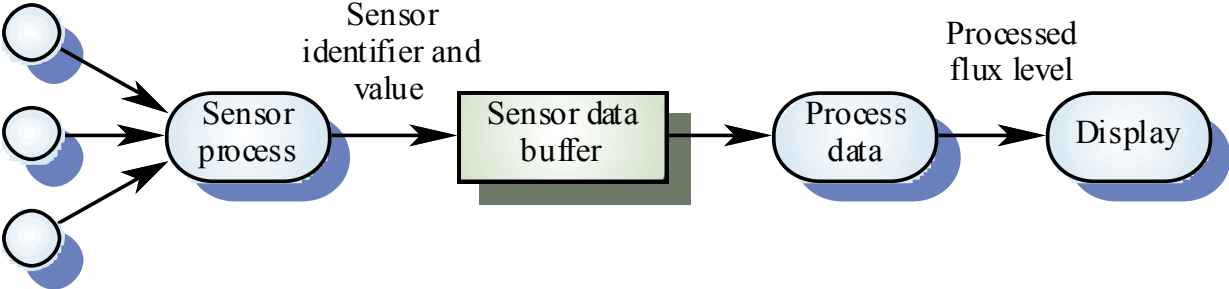

Mutual exclusion:

- Producer processes collect data and add it to the buffer. Consumer processes take data from the buffer and make elements available

- Producer and consumer processes must be mutually excluded from accessing the same element.

The buffer must stop producer processes adding information to a full buffer and consumer processes trying to take information from an empty buffer

System Design

- Design both the hardware and the software associated with system. Partition functions to either hardware or software
- Design decisions should be made on the basis on non-functional system requirements
- Hardware delivers better performance but potentially longer development and less scope for change

System elements

- Sensors control processes
 - Collect information from sensors. May buffer information collected in response to a sensor stimulus
- Data processor
 - Carries out processing of collected information and computes the system response
- Actuator control
 - Generates control signals for the actuator

Sensor/actuator processes

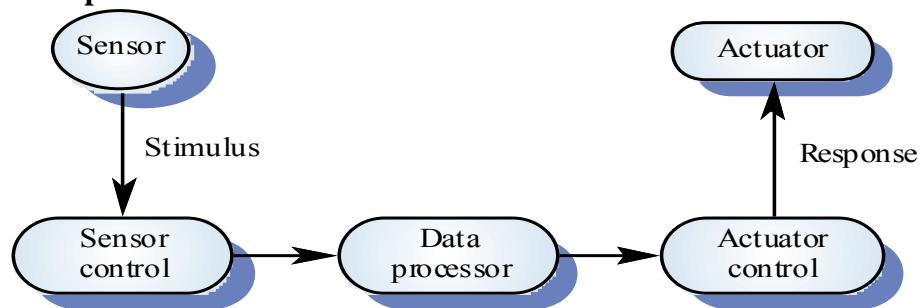

Hardware and software design

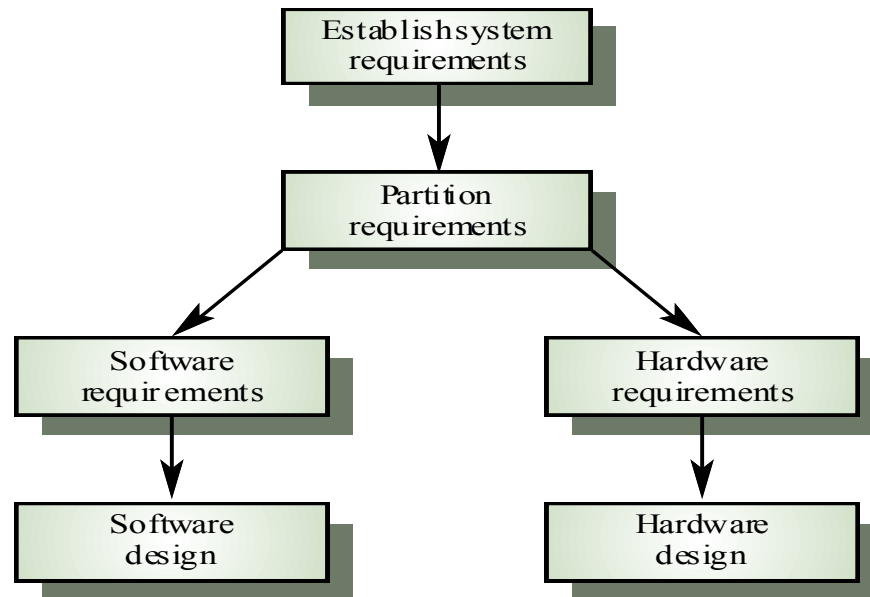

R-T systems design process

- Identify the stimuli to be processed and the required responses to these stimuli
- For each stimulus and response, identify the timing constraints
- Aggregate the stimulus and response processing into concurrent processes. A process may be associated with each class of stimulus and response
- Design algorithms to process each class of stimulus and response. These must meet the given timing requirements
- Design a scheduling system which will ensure that processes are started in time to meet their deadlines
- Integrate using a real-time executive or operating system

Timing constraints

- For aperiodic stimuli, designers make assumptions about probability of occurrence of stimuli.
- May mean that certain design strategies such as object-oriented design cannot be used because of the additional overhead involved

State machine modelling

- The effect of a stimulus in a real-time system may trigger a transition from one state to another.
- Finite state machines can be used for modelling real-time systems.
- However, FSM models lack structure. Even simple systems can have a complex model.
- The UML includes notations for defining state machine models

Microwave oven state machine

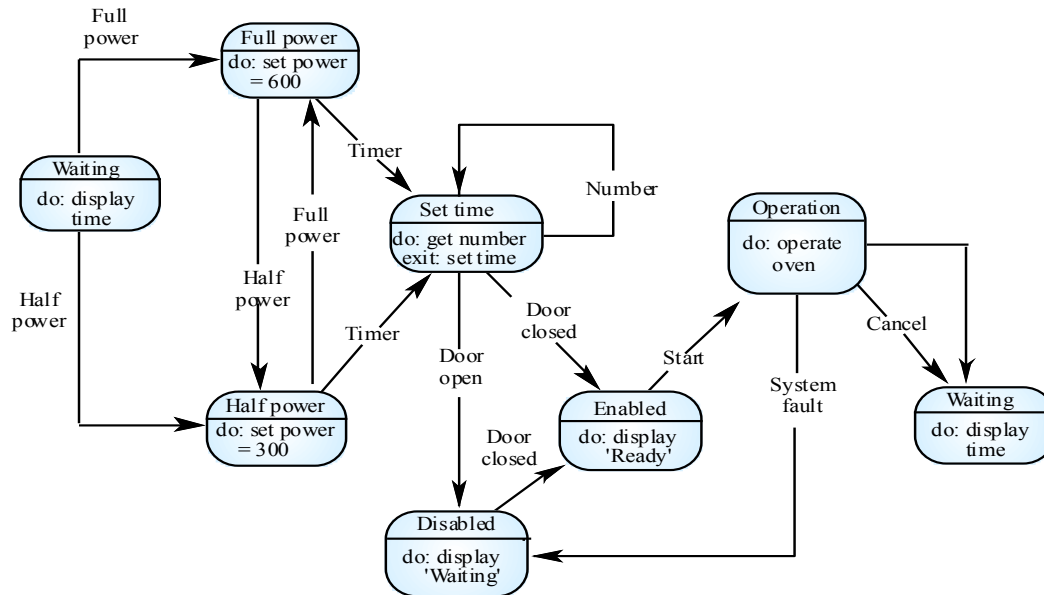

Real-time programming

- Hard-real time systems may have to be programmed in assembly language to ensure that deadlines are met
- Languages such as C allow efficient programs to be written but do not have constructs to support concurrency or shared resource management
- Ada as a language designed to support real-time systems design so includes a general purpose concurrency mechanism

Java as a real-time language

- Java supports lightweight concurrency (threads and synchronized methods) and can be used for some soft real-time systems
- Java 2.0 is not suitable for hard RT programming or programming where precise control of timing is required
 - Not possible to specify thread execution time
 - Uncontrollable garbage collection
 - Not possible to discover queue sizes for shared resources
 - Variable virtual machine implementation
 - Not possible to do space or timing analysis

Real Time Executives

- Real-time executives are specialised operating systems which manage processes in the RTS
- Responsible for process management and resource (processor and memory) allocation
- Storage management, fault management.
- Components depend on complexity of system

Executive components

- Real-time clock
 - Provides information for process scheduling.
- Interrupt handler

- Manages aperiodic requests for service.
- Scheduler
 - Chooses the next process to be run.
- Resource manager
 - Allocates memory and processor resources.
- Dispatchers
 - Starts process execution.

Non-stop system components

- Configuration manager
 - Responsible for the dynamic reconfiguration of the system software and hardware. Hardware modules may be replaced and software upgraded without stopping the systems
- Fault manager
 - Responsible for detecting software and hardware faults and taking appropriate actions (e.g. switching to backup disks) to ensure that the system continues in operation

Real-time executive components

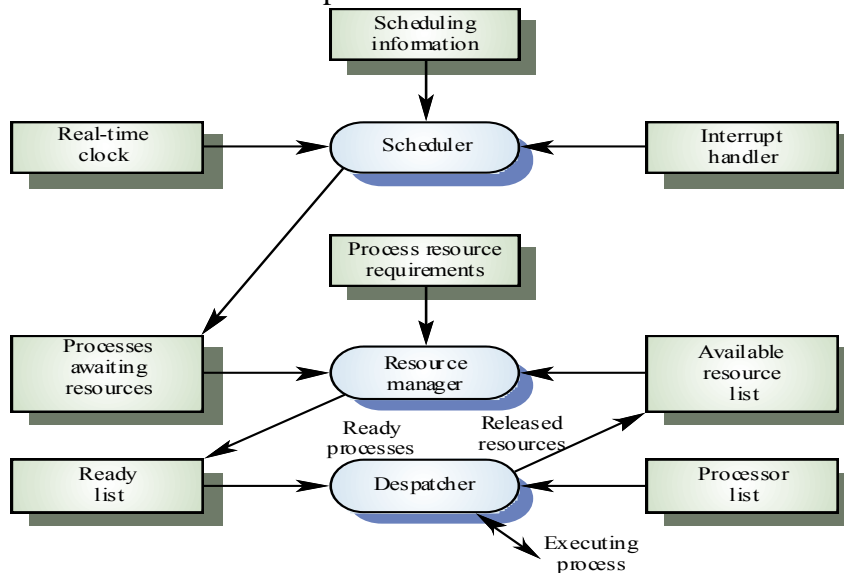

Process priority

- The processing of some types of stimuli must sometimes take priority
- Interrupt level priority. Highest priority which is allocated to processes requiring a very fast response
- Clock level priority. Allocated to periodic processes
- Within these, further levels of priority may be assigned

Interrupt servicing

- Control is transferred automatically to a pre-determined memory location
- This location contains an instruction to jump to an interrupt service routine
- Further interrupts are disabled, the interrupt serviced and control returned to the interrupted process

- Interrupt service routines MUST be short, simple and fast

Periodic process servicing

- In most real-time systems, there will be several classes of periodic process, each with different periods (the time between executions), execution times and deadlines (the time by which processing must be completed)
- The real-time clock ticks periodically and each tick causes an interrupt which schedules the process manager for periodic processes
- The process manager selects a process which is ready for execution

Process management

- Concerned with managing the set of concurrent processes
- Periodic processes are executed at pre-specified time intervals
- The executive uses the real-time clock to determine when to execute a process
- Process period - time between executions
- Process deadline - the time by which processing must be complete

RTE process management

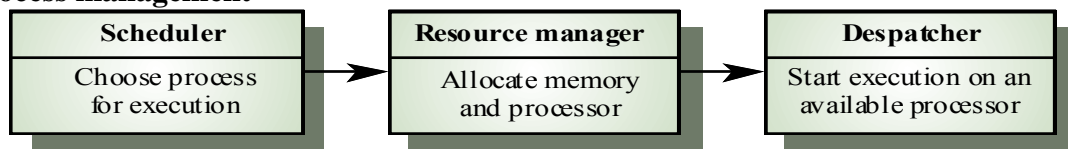

Process switching

- The scheduler chooses the next process to be executed by the processor. This depends on a scheduling strategy which may take the process priority into account
- The resource manager allocates memory and a processor for the process to be executed
- The dispatcher takes the process from ready list, loads it onto a processor and starts execution

Scheduling strategies

- Non pre-emptive scheduling
 - Once a process has been scheduled for execution, it runs to completion or until it is blocked for some reason (e.g. waiting for I/O)
- Pre-emptive scheduling
 - The execution of an executing processes may be stopped if a higher priority process requires service
- Scheduling algorithms
 - Round-robin
 - Shortest deadline first

Data Acquisition System

- Collect data from sensors for subsequent processing and analysis.
- Data collection processes and processing processes may have different periods and deadlines.

- Data collection may be faster than processing
e.g. collecting information about an explosion, scientific experiments
- Circular or ring buffers are a mechanism for smoothing speed differences.

Reactor data collection

- A system collects data from a set of sensors monitoring the neutron flux from a nuclear reactor.
- Flux data is placed in a ring buffer for later processing.
- The ring buffer is itself implemented as a concurrent process so that the collection and processing processes may be synchronized.

Reactor flux monitoring

Sensors (each data flow is a sensor value)

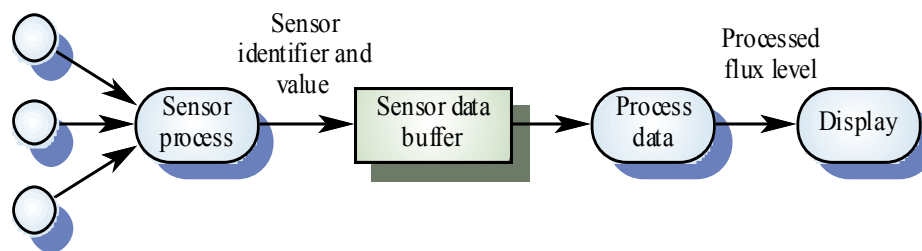

A ring buffer

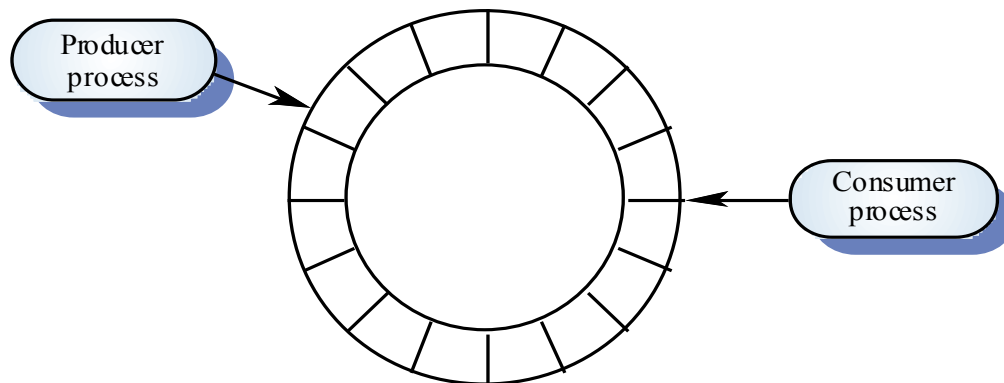

Mutual exclusion

- Producer processes collect data and add it to the buffer. Consumer processes take data from the buffer and make elements available.
- Producer and consumer processes must be mutually excluded from accessing the same element.
- The buffer must stop producer processes adding information to a full buffer and consumer processes trying to take information from an empty buffer.

Java implementation of a ring buffer

```

class CircularBuffer
{
    int bufsize ;
    SensorRecord [] store ;
}
  
```

```

int numberOfEntries = 0 ;
int front = 0, back = 0 ;

CircularBuffer (int n) {
    bufsize = n ;
    store = new SensorRecord [bufsize] ;
} // CircularBuffer

synchronized void put (SensorRecord rec ) throws InterruptedException
{
    if ( numberOfEntries == bufsize)
        wait () ;
    store [back] = new SensorRecord (rec.sensorId, rec.sensorVal) ;
    back = back + 1 ;
    if (back == bufsize)
        back = 0 ;
    numberOfEntries = numberOfEntries + 1 ;
    notify () ;
} // put

synchronized SensorRecord get () throws InterruptedException
{
    SensorRecord result = new SensorRecord (-1, -1) ;
    if (numberOfEntries == 0)
        wait () ;
    result = store [front] ;
    front = front + 1 ;
    if (front == bufsize)
        front = 0 ;
    numberOfEntries = numberOfEntries - 1 ;
    notify () ;
    return result ;
} // get
} // CircularBuffer

```

Monitoring and Control System

- Important class of real-time systems
- Continuously check sensors and take actions depending on sensor values
- Monitoring systems examine sensors and report their results
- Control systems take sensor values and control hardware actuators
- Burglar alarm system e.g
- A system is required to monitor sensors on doors and windows to detect the presence of intruders in a building
- When a sensor indicates a break-in, the system switches on lights around the area and calls police automatically

- The system should include provision for operation without a mains power supply

Burglar alarm system

- Sensors
 - Movement detectors, window sensors, door sensors.
 - 50 window sensors, 30 door sensors and 200 movement detectors
 - Voltage drop sensor
- Actions
 - When an intruder is detected, police are called automatically.
 - Lights are switched on in rooms with active sensors.
 - An audible alarm is switched on.
 - The system switches automatically to backup power when a voltage drop is detected.

The R-T system design process

- Identify stimuli and associated responses
- Define the timing constraints associated with each stimulus and response
- Allocate system functions to concurrent processes
- Design algorithms for stimulus processing and response generation
- Design a scheduling system which ensures that processes will always be scheduled to meet their deadlines
- Stimuli to be processed
- Power failure
 - Generated by a circuit monitor. When received, the system must switch to backup power within 50 ms
- Intruder alarm
 - Stimulus generated by system sensors. Response is to call the police, switch on building lights and the audible alarm

Timing requirements

Stimulus/Response	Timing requirements
Power fail interrupt	The switch to backup power must be completed within a deadline of 50 ms.
Door alarm	Each door alarm should be polled twice per second.
Window alarm	Each window alarm should be polled twice per second.
Movement detector	Each movement detector should be polled twice per second.
Audible alarm	The audible alarm should be switched on within 1/2 second of an alarm being raised by a sensor.
Lights switch	The lights should be switched on within 1/2 second of an alarm being raised by a sensor.
Communications	The call to the police should be started within 2 seconds of an alarm being raised by a sensor.
Voice synthesiser	A synthesised message should be available within 4 seconds of an alarm being raised by a sensor.

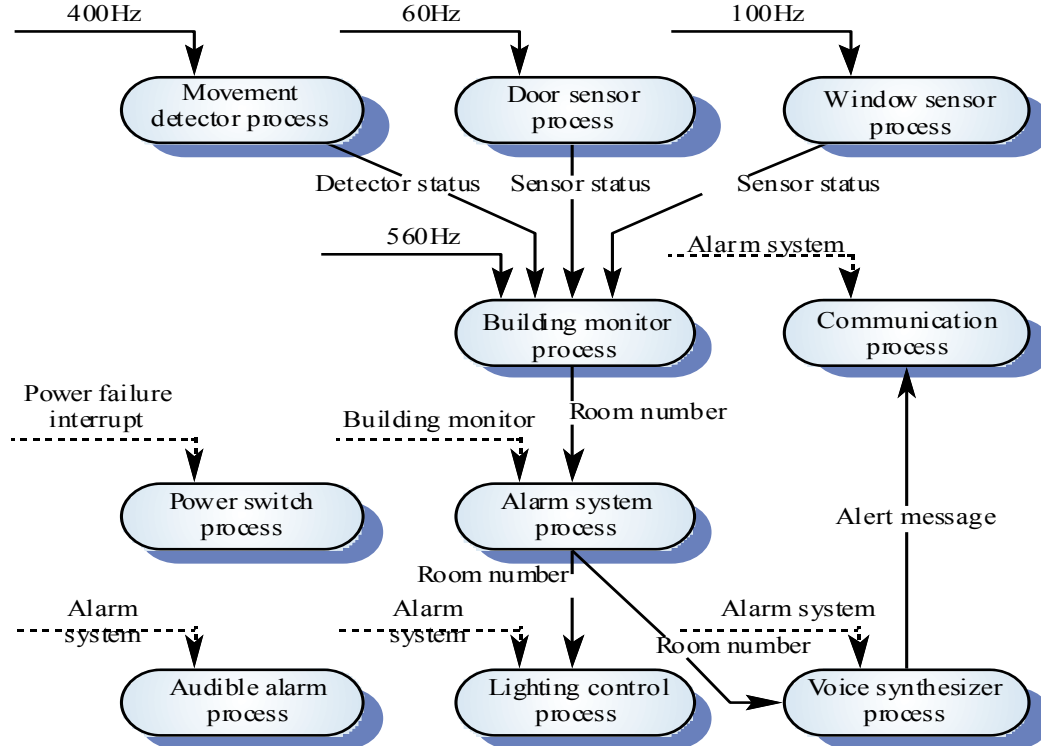
Process architecture**Building monitor process**

```

class BuildingMonitor extends Thread {

    BuildingSensor win, door, move ;

    Siren siren = new Siren () ;
    Lights lights = new Lights () ;
    Synthesizer synthesizer = new Synthesizer () ;
    DoorSensors doors = new DoorSensors (30) ;
    WindowSensors windows = new WindowSensors (50) ;
    MovementSensors movements = new MovementSensors (200) ;
    PowerMonitor pm = new PowerMonitor () ;

    BuildingMonitor()
    {
        // initialise all the sensors and start the processes
        siren.start () ; lights.start () ;
        synthesizer.start () ; windows.start () ;
        doors.start () ; movements.start () ; pm.start () ;
    }
}

```

```

public void run ()
{
    int room = 0 ;
    while (true)
    {
        // poll the movement sensors at least twice per second (400 Hz)
        move = movements.getVal () ;
        // poll the window sensors at least twice/second (100 Hz)
        win = windows.getVal () ;
        // poll the door sensors at least twice per second (60 Hz)
        door = doors.getVal () ;
        if (move.sensorVal == 1 | door.sensorVal == 1 | win.sensorVal == 1)
        {
            // a sensor has indicated an intruder
            if (move.sensorVal == 1)    room = move.room ;
            if (door.sensorVal == 1)    room = door.room ;
            if (win.sensorVal == 1)     room = win.room ;

            lights.on (room) ; siren.on () ; synthesizer.on (room) ;
            break ;
        }
    }
    lights.shutdown () ; siren.shutdown () ; synthesizer.shutdown () ;
    windows.shutdown () ; doors.shutdown () ; movements.shutdown () ;

} // run
} //BuildingMonitor

```

A temperature control system

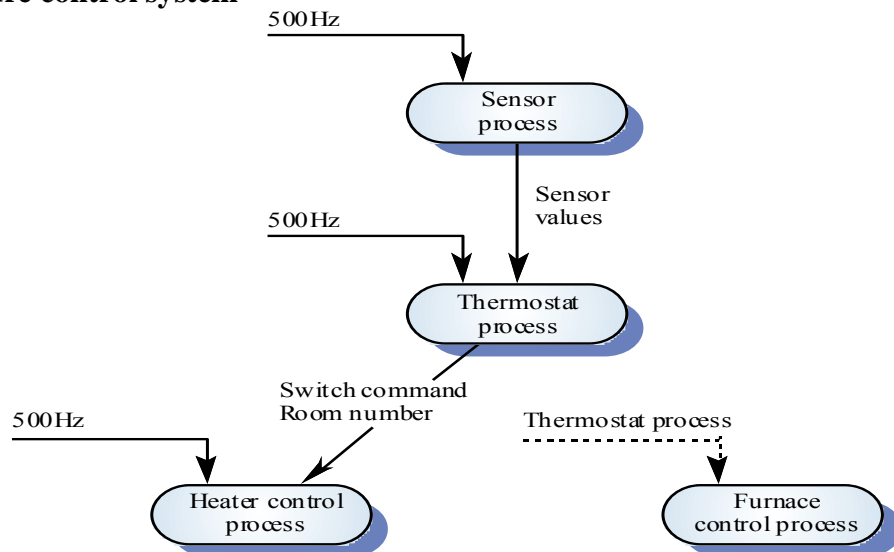

Control systems

- A burglar alarm system is primarily a monitoring system. It collects data from sensors but no real-time actuator control
- Control systems are similar but, in response to sensor values, the system sends control signals to actuators
- An example of a monitoring and control system is a system which monitors temperature and switches heaters on and off

UNIT IV

TESTING

Taxonomy of Software Testing

- Classified by purpose, software testing can be divided into: correctness testing, performance testing, and reliability testing and security testing.
- Classified by life-cycle phase, software testing can be classified into the following categories: requirements phase testing, design phase testing, program phase testing, evaluating test results, installation phase testing, acceptance testing and maintenance testing.
- By scope, software testing can be categorized as follows: unit testing, component testing, integration testing, and system testing.

Correctness testing

Correctness is the minimum requirement of software, the essential purpose of testing. It is used to tell the right behavior from the wrong one. The tester may or may not know the inside details of the software module under test, e.g. control flow, data flow, etc. Therefore, either a white-box point of view or black-box point of view can be taken in testing software. We must note that the black-box and white-box ideas are not limited in correctness testing only.

- Black-box testing
- White-box testing

Performance testing

Not all software systems have specifications on performance explicitly. But every system will have implicit performance requirements. The software should not take infinite time or infinite resource to execute. "Performance bugs" sometimes are used to refer to those design problems in software that cause the system performance to degrade.

Performance has always been a great concern and a driving force of computer evolution. Performance evaluation of a software system usually includes: resource usage, throughput, stimulus-response time and queue lengths detailing the average or maximum number of tasks waiting to be serviced by selected resources. Typical resources that need to be considered include network bandwidth requirements, CPU cycles, disk space, disk access operations, and memory usage. The goal of performance testing can be performance bottleneck identification, performance comparison and evaluation, etc.

Reliability testing

Software reliability refers to the probability of failure-free operation of a system. It is related to many aspects of software, including the testing process. Directly estimating software reliability by quantifying its related factors can be difficult. Testing is an effective sampling method to measure software reliability. Guided by the operational profile, software testing (usually black-box testing) can be used to obtain failure data, and an estimation model can be further used to analyze the data to estimate the present reliability and predict future reliability. Therefore, based on the estimation, the developers can decide whether to release the software, and the users can decide whether to adopt and use the software. Risk of using software can also be assessed based on reliability information.

Security testing

Software quality, reliability and security are tightly coupled. Flaws in software can be exploited by intruders to open security holes. With the development of the Internet, software security problems are becoming even more severe. Many critical software applications and services have integrated security measures against malicious attacks. The purpose of security testing of these systems include identifying and removing software flaws that may potentially lead to security violations, and validating the effectiveness of security measures. Simulated security attacks can be performed to find vulnerabilities.

Types of S/W Test

Acceptance testing

Testing to verify a product meets customer specified requirements. A customer usually does this type of testing on a product that is developed externally.

Compatibility testing

This is used to ensure compatibility of an application or Web site with different browsers, OSs, and hardware platforms. Compatibility testing can be performed manually or can be driven by an automated functional or regression test suite.

Conformance testing

This is used to verify implementation conformance to industry standards. Producing tests for the behavior of an implementation to be sure it provides the portability, interoperability, and/or compatibility a standard defines.

Integration testing

Modules are typically code modules, individual applications, client and server applications on a network, etc. Integration Testing follows unit testing and precedes system testing.

Load testing

Load testing is a generic term covering Performance Testing and Stress Testing.

Performance testing

Performance testing can be applied to understand your application or WWW site's scalability, or to benchmark the performance in an environment of third party products such as servers and middleware for potential purchase. This sort of testing is particularly useful to identify performance bottlenecks in high use applications. Performance testing generally involves an automated test suite as this allows easy simulation of a variety of normal, peak, and exceptional load conditions.

Regression testing

Similar in scope to a functional test, a regression test allows a consistent, repeatable validation of each new release of a product or Web site. Such testing ensures reported product defects have been corrected for each new release and that no new quality problems were introduced in the maintenance process. Though regression testing can be performed manually an automated test suite is often used to reduce the time and resources needed to perform the required testing.

System testing

Entire system is tested as per the requirements. Black-box type testing that is based on overall requirements specifications, covers all combined parts of a system.

End-to-end testing

Similar to system testing, involves testing of a complete application environment in a situation that mimics real-world use, such as interacting with a database, using network communications, or interacting with other hardware, applications, or systems if appropriate.

Sanity testing

Testing is to determine if a new software version is performing well enough to accept it for a major testing effort. If application is crashing for initial use then system is not stable enough for further testing and build or application is assigned to fix.

Alpha testing

In house virtual user environment can be created for this type of testing. Testing is done at the end of development. Still minor design changes may be made as a result of such testing.

Beta testing

Testing is typically done by end-users or others. This is the final testing before releasing the application to commercial purpose.

Software Testing Techniques

Software Testing:

Testing is the process of exercising a program with the specific intent of finding errors prior to delivery to the end user.

Testing Objectives:

- Testing is the process of executing a program with the intent of finding errors.
- A good test case is one with a high probability of finding an as-yet undiscovered error.
- A successful test is one that discovers an as-yet-undiscovered error.

Testing Principles:

- All tests should be traceable to customer requirements.
- Tests should be planned before testing begins.
- 80% of all errors are in 20% of the code.
- Testing should begin in the small and progress to the large.
- Exhaustive testing is not possible.

Testing should be conducted by an independent third party if possible.

Software Defect Causes:

- Specification may be wrong.
- Specification may be a physical impossibility.
- Faulty program design.
- Program may be incorrect.

Types of Errors:

- Algorithmic error.
- Computation & precision error.
- Documentation error.
- Capacity error or boundary error.
- Timing and coordination error.
- Throughput or performance error.
- Recovery error.
- Hardware & system software error.
- Standards & procedure errors.

Software Testability Checklist – 1:

- Operability
 - if it works better it can be tested more efficiently
- Observability
 - what you see is what you test
- Controllability
 - if software can be controlled better the it is more that testing can be automated and optimized

Software Testability Checklist – 2:

- Decomposability
 - controlling the scope of testing allows problems to be isolated quickly and retested intelligently
- Stability
 - the fewer the changes, the fewer the disruptions to testing
- Understandability
 - the more information that is known, the smarter the testing can be done

Good Test Attributes:

- A good test has a high probability of finding an error.
- A good test is not redundant.
- A good test should be best of breed.
- A good test should not be too simple or too complex.

Test Strategies:

- Black-box or behavioral testing

- knowing the specified function a product is to perform and demonstrating correct operation based solely on its specification without regard for its internal logic
- White-box or glass-box testing
 - knowing the internal workings of a product, tests are performed to check the workings of all possible logic paths

White-Box Testing:**Basis Path Testing:**

- White-box technique usually based on the program flow graph
- The cyclomatic complexity of the program computed from its flow graph using the formula $V(G) = E - N + 2$ or by counting the conditional statements in the PDL representation and adding 1
- Determine the basis set of linearly independent paths (the cardinality of this set is the program cyclomatic complexity)
- Prepare test cases that will force the execution of each path in the basis set.

Cyclomatic Complexity:

A number of industry studies have indicated that the higher $V(G)$, the higher the probability or errors.

Control Structure Testing – 1:

- White-box techniques focusing on control structures present in the software
- **Condition testing (e.g. branch testing)**
 - focuses on testing each decision statement in a software module
 - it is important to ensure coverage of all logical combinations of data that may be processed by the module (a truth table may be helpful)

Control Structure Testing – 2:

- Data flow testing
 - selects test paths based according to the locations of variable definitions and uses in the program (e.g. definition use chains)
- Loop testing
 - focuses on the validity of the program loop constructs (i.e. while, for, go to)
 - involves checking to ensure loops start and stop when they are supposed to (unstructured loops should be redesigned whenever possible)

Loop Testing: Simple Loops:**Minimum conditions—Simple Loops**

1. skip the loop entirely
 2. only one pass through the loop
 3. two passes through the loop
 4. m passes through the loop $m < n$
 5. (n-1), n, and (n+1) passes through the loop
- where n is the maximum number of allowable passes

Loop Testing: Nested Loops:**Nested Loops**

Start at the innermost loop. Set all outer loops to their minimum iteration parameter values.

Test the min+1, typical, max-1 and max for the innermost loop, while holding the outer loops at their minimum values.

Move out one loop and set it up as in step 2, holding all other loops at typical values. Continue this step until the outermost loop has been tested.

Concatenated Loops

If the loops are independent of one another

then treat each as a simple loop

else* treat as nested loops

end if*

for example, the final loop counter value of loop 1 is used to initialize loop 2.

Black-Box Testing:

Graph-Based Testing – 1:

- Black-box methods based on the nature of the relationships (links) among the program objects (nodes), test cases are designed to traverse the entire graph
- Transaction flow testing
 - nodes represent steps in some transaction and links represent logical connections between steps that need to be validated
- Finite state modeling
 - nodes represent user observable states of the software and links represent state transitions

Graph-Based Testing – 2:

- Data flow modeling
 - nodes are data objects and links are transformations of one data object to another data object
- Timing modeling
 - nodes are program objects and links are sequential connections between these objects
 - link weights are required execution times

Equivalence Partitioning:

- Black-box technique that divides the input domain into classes of data from which test cases can be derived
- An ideal test case uncovers a class of errors that might require many arbitrary test cases to be executed before a general error is observed

Equivalence Class Guidelines:

- If input condition specifies a range, one valid and two invalid equivalence classes are defined
- If an input condition requires a specific value, one valid and two invalid equivalence classes are defined
- If an input condition specifies a member of a set, one valid and one invalid equivalence class is defined
- If an input condition is Boolean, one valid and one invalid equivalence class is defined
- Boundary Value Analysis - 1
- Black-box technique
 - focuses on the boundaries of the input domain rather than its center
- Guidelines:

- If input condition specifies a range bounded by values a and b, test cases should include a and b, values just above and just below a and b
- If an input condition specifies and number of values, test cases should be exercise the minimum and maximum numbers, as well as values just above and just below the minimum and maximum values

Boundary Value Analysis – 2

1. Apply guidelines 1 and 2 to output conditions, test cases should be designed to produce the minimum and maximum output reports
2. If internal program data structures have boundaries (e.g. size limitations), be certain to test the boundaries

Comparison Testing:

- Black-box testing for safety critical systems in which independently developed implementations of redundant systems are tested for conformance to specifications
- Often equivalence class partitioning is used to develop a common set of test cases for each implementation

Orthogonal Array Testing – 1:

- Black-box technique that enables the design of a reasonably small set of test cases that provide maximum test coverage
- Focus is on categories of faulty logic likely to be present in the software component (without examining the code)

Orthogonal Array Testing – 2:

- Priorities for assessing tests using an orthogonal array
 - Detect and isolate all single mode faults
 - Detect all double mode faults
 - Multimode faults

Software Testing Strategies:**Strategic Approach to Testing – 1:**

- Testing begins at the component level and works outward toward the integration of the entire computer-based system.
- Different testing techniques are appropriate at different points in time.
- The developer of the software conducts testing and may be assisted by independent test groups for large projects.
- The role of the independent tester is to remove the conflict of interest inherent when the builder is testing his or her own product.

Strategic Approach to Testing – 2:

- Testing and debugging are different activities.
- Debugging must be accommodated in any testing strategy.
- Need to consider verification issues
 - are we building the product right?
- Need to Consider validation issues are we building the right product?

Verification vs validation:

- Verification:
"Are we building the product right" The software should conform to its specification
- Validation:
"Are we building the right product" The software should do what the user really requires

The V & V process:

- As a whole life-cycle process - V & V must be applied at each stage in the software process.
- Has two principal objectives
 - The discovery of defects in a system
 - The assessment of whether or not the system is usable in an operational situation.
- Strategic Testing Issues - 1 Specify product requirements in a quantifiable manner before testing starts.
- Specify testing objectives explicitly.
- Identify the user classes of the software and develop a profile for each.
- Develop a test plan that emphasizes rapid cycle testing.

Strategic Testing Issues – 2:

- Build robust software that is designed to test itself (e.g. use anti-bugging).
- Use effective formal reviews as a filter prior to testing.
- Conduct formal technical reviews to assess the test strategy and test cases.

Testing Strategy:

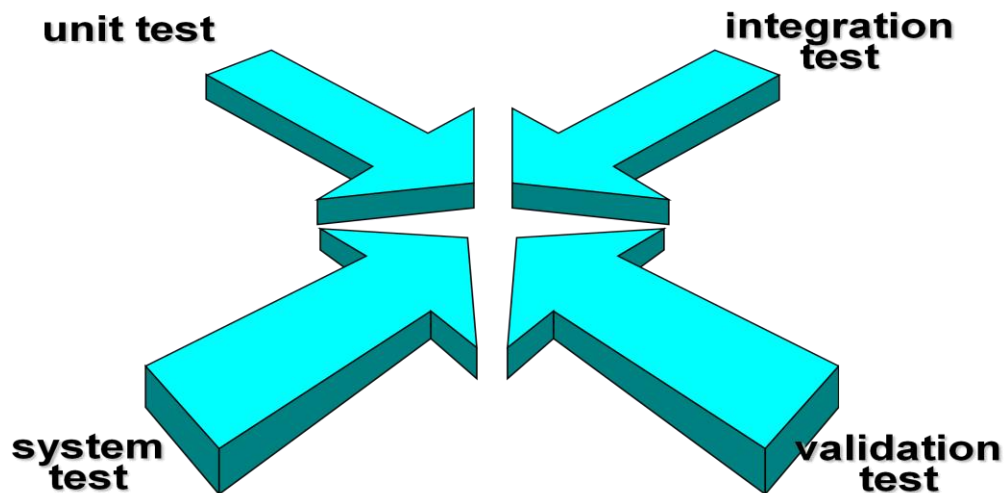

Unit Testing:

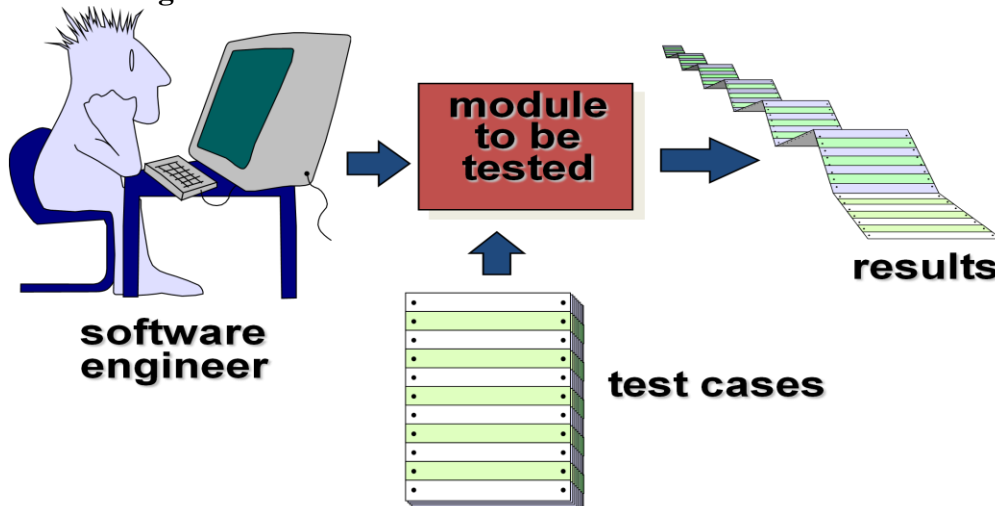

- Program reviews.
- Formal verification.
- Testing the program itself.
 - black box and white box testing.

Black Box or White Box?:

- Maximum # of logic paths - determine if white box testing is possible.
- Nature of input data.
- Amount of computation involved.
- Complexity of algorithms.

Unit Testing Details:

- Interfaces tested for proper information flow.
- Local data are examined to ensure that integrity is maintained.
- Boundary conditions are tested.
- Basis path testing should be used.
- All error handling paths should be tested.
- Drivers and/or stubs need to be developed to test incomplete software.

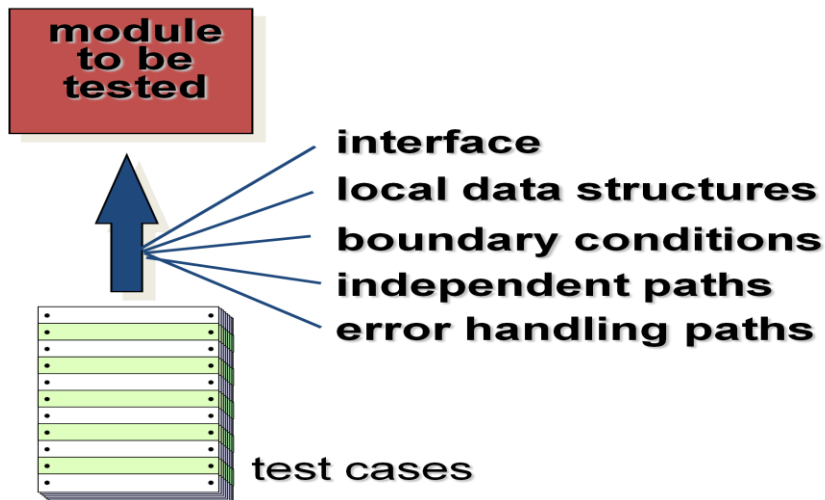
Unit Testing:**Unit Test Environment:**

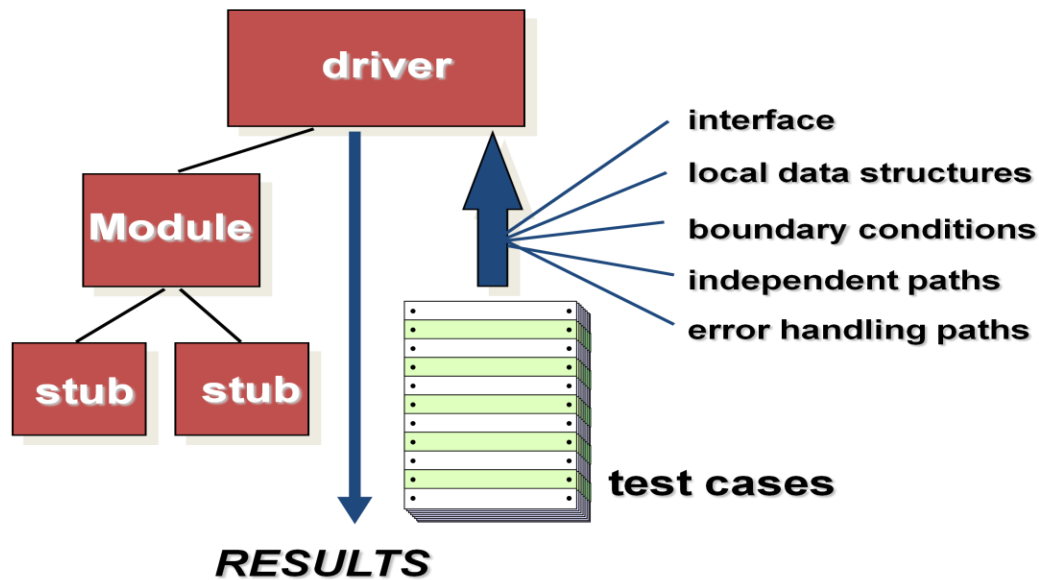

Integration Testing:

- Bottom - up testing (test harness).
- Top - down testing (stubs).
- Regression Testing.
- Smoke Testing

Top Down Integration:

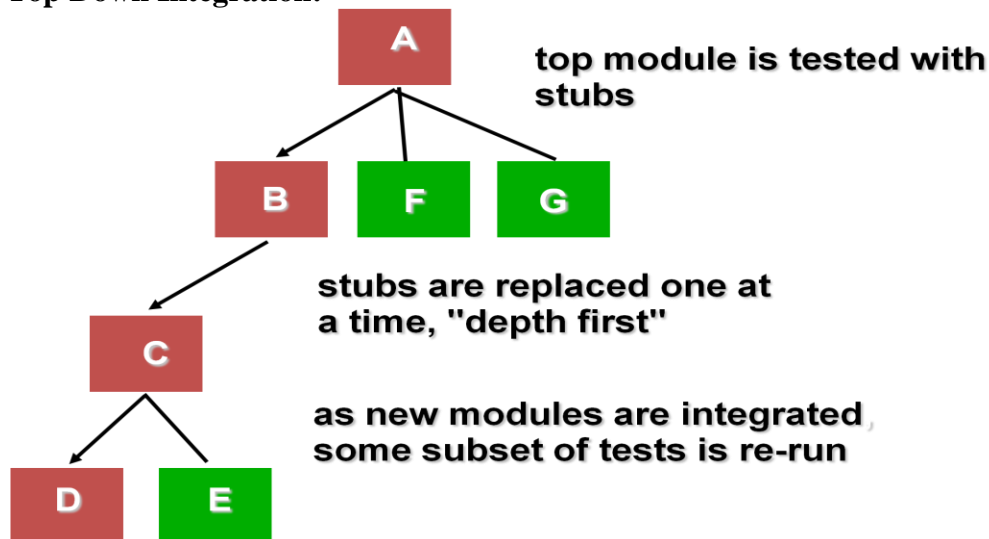

Top-Down Integration Testing:

- Main program used as a test driver and stubs are substitutes for components directly subordinate to it.
- Subordinate stubs are replaced one at a time with real components (following the depth-first or breadth-first approach).
- Tests are conducted as each component is integrated.
- On completion of each set of tests and other stub is replaced with a real component.

- Regression testing may be used to ensure that new errors not introduced.

Bottom-Up Integration:

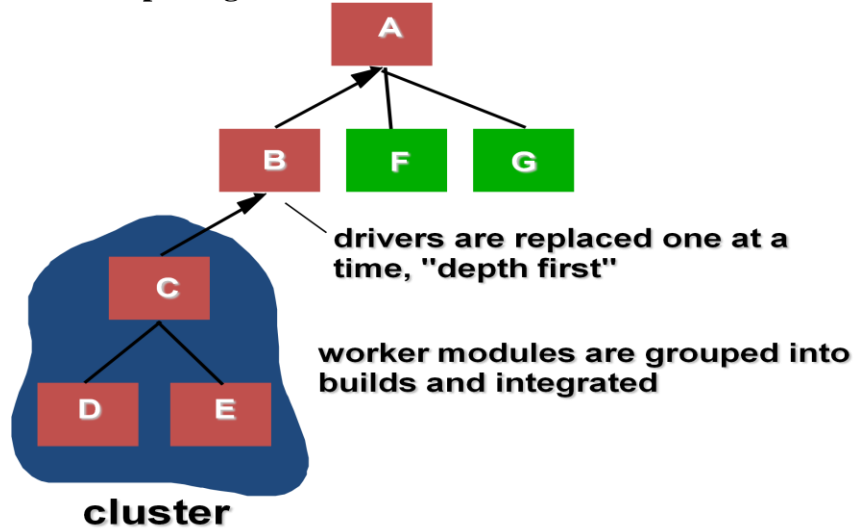

Bottom-Up Integration Testing:

- Low level components are combined in clusters that perform a specific software function.
- A driver (control program) is written to coordinate test case input and output.
- The cluster is tested.
- Drivers are removed and clusters are combined moving upward in the program structure.

Regression Testing:

- The selective retesting of a software system that has been modified to ensure that any bugs have been fixed and that no other previously working functions have failed as a result of the reparations and that newly added features have not created problems with previous versions of the software. Also referred to as verification testing, regression testing is initiated after a programmer has attempted to fix a recognized problem or has added source code to a program that may have inadvertently introduced errors. It is a quality control measure to ensure that the newly modified code still complies with its specified requirements and that unmodified code has not been affected by the maintenance activity.

Regression Testing:

- Regression test suit contains 3 different classes of test cases
 - Representative sample of existing test cases is used to exercise all software functions.
 - Additional test cases focusing software functions likely to be affected by the change.
 - Tests cases that focus on the changed software components.

Smoke Testing:

- Software components already translated into code are integrated into a build.
- A series of tests designed to expose errors that will keep the build from performing its functions are created.
- The build is integrated with the other builds and the entire product is smoke tested daily using either top-down or bottom integration.

Validation Testing:

- Ensure that each function or performance characteristic conforms to its specification.
- Deviations (deficiencies) must be negotiated with the customer to establish a means for resolving the errors.
- Configuration review or audit is used to ensure that all elements of the software configuration have been properly developed, cataloged, and documented to allow its support during its maintenance phase.

Acceptance Testing:

- Making sure the software works correctly for intended user in his or her normal work environment.
- Alpha test
 - version of the complete software is tested by customer under the supervision of the developer at the developer's site
- Beta test
 - version of the complete software is tested by customer at his or her own site without the developer being present

System Testing:

- Recovery testing
 - checks system's ability to recover from failures
- Security testing
 - verifies that system protection mechanism prevents improper penetration or data alteration
- Stress testing
 - program is checked to see how well it deals with abnormal resource demands
- Performance testing
 - tests the run-time performance of software

Performance Testing:

- Stress test.
- Volume test.
- Configuration test (hardware & software).
- Compatibility.
- Regression tests.
- Security tests.
- Timing tests.
- Environmental tests.
- Quality tests.
- Recovery tests.
- Maintenance tests.
- Documentation tests.
- Human factors tests.

Testing Life Cycle:

- Establish test objectives.
- Design criteria (review criteria).
 - Correct.
 - Feasible.
 - Coverage.
 - Demonstrate functionality.

- Writing test cases.
- Testing test cases.
- Execute test cases.
- Evaluate test results.

Testing Tools:

- Simulators.
- Monitors.
- Analyzers.
- Test data generators.

Document Each Test Case:

- Requirement tested.
- Facet / feature / path tested.
- Person & date.
- Tools & code needed.
- Test data & instructions.
- Expected results.
- Actual test results & analysis
- Correction, schedule, and signoff.

Debugging:

- Debugging (removal of a defect) occurs as a consequence of successful testing.
- Some people better at debugging than others.
- Is the cause of the bug reproduced in another part of the program?
- What “next bug” might be introduced by the fix that is being proposed?
- What could have been done to prevent this bug in the first place?

Software Implementation techniques

- Implementation techniques include imperative languages (object-oriented or procedural), functional languages, and logic languages.
- Software Implementation Techniques include process and thread scheduling, synchronization and concurrency primitives, file management, memory management, performance, networking facilities, and user interfaces. Software Implementation Techniques is designed to facilitate determining what is required to implement a specific operating system function.

Procedural programming

Procedural programming can sometimes be used as a synonym for imperative programming (specifying the steps the program must take to reach the desired state), but can also refer (as in this article) to a programming paradigm, derived from structured programming, based upon the concept of the procedure call. Procedures, also known as routines, subroutines, methods, or functions (not to be confused with mathematical functions, but similar to those used in functional programming) simply contain a series of computational steps to be carried out. Any given procedure might be called at any point during a program's execution, including by other procedures or itself. Some good examples of procedural programs are the Linux Kernel, GIT, Apache Server, and Quake III Arena.

Object-oriented programming

Object-oriented programming (OOP) is a programming paradigm that uses "objects" – data structures consisting of data fields and methods together with their interactions – to design applications and computer programs. Programming techniques may include features such as data abstraction, encapsulation, modularity, polymorphism, and inheritance. Many modern programming languages now support OOP.

An object-oriented program may thus be viewed as a collection of interacting *objects*, as opposed to the conventional model, in which a program is seen as a list of tasks (subroutines) to perform. In OOP, each object is capable of receiving messages, processing data, and sending messages to other objects. Each object can be viewed as an independent 'machine' with a distinct role or responsibility. The actions (or "methods") on these objects are closely associated with the object. For example, OOP data structures tend to 'carry their own operators around with them' (or at least "inherit" them from a similar object or class). In the conventional model, the data and operations on the data don't have a tight, formal association.

functional programming is a programming paradigm that treats computation as the evaluation of mathematical functions and avoids state and mutable data. It emphasizes the application of functions, in contrast to the imperative programming style, which emphasizes changes in state. Functional programming has its roots in lambda calculus, a formal system developed in the 1930s to investigate function definition, function application, and recursion. Many functional programming languages can be viewed as elaborations on the lambda calculus.

In practice, the difference between a mathematical function and the notion of a "function" used in imperative programming is that imperative functions can have side effects, changing the value of already calculated computations. Because of this they lack referential transparency, i.e. the same language expression can result in different values at different times depending on the state of the executing program. Conversely, in functional code, the output value of a function depends only on the arguments that are input to the function, so calling a function f twice with the same value for an argument x will produce the same result $f(x)$ both times. Eliminating side effects can make it much easier to understand and predict the behavior of a program, which is one of the key motivations for the development of functional programming. JavaScript, one of the most widely employed languages today, incorporates functional programming capabilities.

Logic programming is, in its broadest sense, the use of mathematical logic for computer programming. In this view of logic programming, which can be traced at least as far back as John McCarthy's [1958] advice-taker proposal, logic is used as a purely declarative representation language, and a theorem-prover or model-generator is used as the problem-solver. The problem-solving task is split between the programmer, who is responsible only for ensuring the truth of programs expressed in logical form, and the theorem-prover or model-generator, which is responsible for solving problems efficiently.

Oracle's Application Implementation Method

AIM provides with an integrated set of templates, procedures, PowerPoint presentations, spreadsheets, and project plans for implementing the applications. AIM was such a success, Oracle created a subset of the templates, called it AIM Advantage, and made it available as a product to customers and other consulting firms. Since its initial release, AIM has been revised and improved several times with new templates and methods.

AIM Is a Six-Phase Method

Because the Oracle ERP Applications are software modules buy from a vendor, different implementation methods are used than the techniques used for custom developed systems. AIM has six major phases:

- **Definition phase:** During this phase, you plan the project, determine business objectives, and verify the feasibility of the project for given time, resource, and budget limits.
- **Operations Analysis phase:** Includes documents business requirements, gaps in the software (which can lead to customizations), and system architecture requirements. Results of the analysis should provide a proposal for future business processes, a technical architecture model, an application architecture model, workarounds for application gaps, performance testing models, and a transition strategy to migrate to the new systems. Another task that can begin in this phase is mapping of legacy data to Oracle Application APIs or open interfaces—data conversion.
- **Solution Design phase**—Used to create designs for solutions that meet future business requirements and processes. The design of your future organization comes alive during this phase as customizations and module configurations are finalized.
- **Build phase**—During this phase of AIM, coding and testing of customizations, enhancements, interfaces, and data conversions happens. In addition, one or more conference room pilots test the integrated enterprise system. The results of the build phase should be a working, tested business system solution.
- **Transition phase**—During this phase, the project team delivers the finished solution to the enterprise. End-user training and support, management of change, and data conversions are major activities of this phase.
- **Production phase**—Starts when the system goes live. Technical people work to stabilize and maintain the system under full transaction loads. Users and the implementation team begin a series of refinements to minimize unfavorable impacts and realize the business objectives identified in the definition phase.

Rapid Implementations

In the late 1990s as Y2K approached, customers demanded and consulting firms discovered faster ways to implement packaged software applications. The rapid implementation became possible for certain types of customers. The events that converged in the late 1990s to provide faster implementations include the following:

- Many smaller companies couldn't afford the big ERP project. If the software vendors and consulting firms were going to sell to the "middle market" companies, they had to develop more efficient methods.
- Many dotcoms needed a financial infrastructure; ERP applications filled the need, and rapid implementation methods provided the way.
- The functionality of the software improved a lot, many gaps were eliminated, and more companies could implement with fewer customizations.
- After the big, complex companies implemented their ERP systems, the typical implementation became less difficult.
- The number of skilled consultants and project managers increased significantly.
- Other software vendors started packaging preprogrammed integration points to the Oracle ERP modules.

Rapid implementations focus on delivering a predefined set of functionality. A key set of business processes is installed in a standard way to accelerate the implementation schedule. These projects benefit from the use of preconfigured modules and predefined business processes. You get to reuse the analysis and integration testing from other implementations, and you agree to ignore all gaps by modifying your business to fit the software. Typically, the enterprise will be allowed some control over key decisions such as the structure of the chart of accounts. Fixed budgets are set for training, production support, and data conversions (a limited amount of data).

Phased Implementations

Phased implementations seek to break up the work of an ERP implementation project. This technique can make the system more manageable and reduce risks, and costs in some cases, to the enterprise. In the mid-1990s, 4 or 5 was about the maximum number of application modules that could be launched into production at one time. If you bought 12 or 13 applications, there would be a financial phase that would be followed by phases for the distribution and manufacturing applications. As implementation techniques improved and Y2K pressures grew in the late 1990s, more and more companies started launching most of their applications at the same time. This method became known as the big-bang approach. Now, each company selects a phased or big-bang approach based on its individual requirements.

Another approach to phasing can be employed by companies with business units at multiple sites. With this technique, one business unit is used as a template, and all applications are completely implemented in an initial phase lasting 10–14 months. Then, other sites implement the applications in cookie-cutter fashion. The cookie-cutter phases are focused on end-user training and the differences that a site has from the prototype site. The cookie-cutter phase can be as short as 9–12 weeks, and these phases can be conducted at several sites simultaneously. For your reference, we participated in an efficient project where 13 applications were implemented big bang–style in July at the Chicago site after about 8 months work. A site in Malaysia went live in October. The Ireland site started up in November. After a holiday break, the Atlanta business unit went live in February, and the final site in China started using the applications in April. Implementing thirteen application modules at five sites in four countries in sixteen months was pretty impressive.

Case Studies Illustrating Implementation Techniques

Some practical examples from the real world might help to illustrate some of the principles and techniques of various software implementation methods. These case studies are composites from about 60 implementation projects we have observed during the past 9 years.

Big companies often have a horrible time resolving issues and deciding on configuration parameters because there is so much money involved and each of many sites might want to control decisions about what it considers its critical success factors. For example, we once saw a large company argue for over two months about the chart of accounts structure, while eight consultants from two consulting firms tried to referee among the feuding operating units. Another large company labored for more than six months to unify a master customer list for a centralized receivables and decentralized order entry system.

Transition activities at large companies need special attention. Training end users can be a logistical challenge and can require considerable planning. For example, if you have 800 users to train and each user needs an average of three classes of two hours each and you have one month, how many classrooms and instructors do you need? Another example is that loading data

from a legacy system can be a problem. If you have one million customers to load into Oracle receivables at the rate of 5,000/hour and the database administrator allows you to load 20 hours per day, you have a 10-day task.

Because they spend huge amounts of money on their ERP systems, many big companies try to optimize the systems and capture specific returns on the investment. However, sometimes companies can be incredibly insensitive and uncoordinated as they try to make money from their ERP software. For example, one business announced at the beginning of a project that the accounts payable department would be cut from 50–17 employees as soon as the system went live. Another company decided to centralize about 30 accounting sites into one shared service center and advised about 60 accountants that they would lose their jobs in about a year. Several of the 60 employees were offered positions on the ERP implementation team.

Small companies have other problems when creating an implementation team. Occasionally, the small company tries to put clerical employees on the team and they have problems with issue resolution or some of the ERP concepts. In another case, one small company didn't create the position of project manager. Each department worked on its own modules and ignored the integration points, testing, and requirements of other users. When Y2K deadlines forced the system startup, results were disastrous with a cost impact that doubled the cost of the entire project.

Project team members at small companies sometimes have a hard time relating to the cost of the implementation. We once worked with a company where the project manager (who was also the database administrator) advised me within the first hour of our meeting that he thought consulting charges of \$3/minute were outrageous, and he couldn't rationalize how we could possibly make such a contribution. We agreed a consultant could not contribute \$3 in value each and every minute to his project. However, when I told him we would be able to save him \$10,000/week and make the difference between success and failure, he realized we should get to work.

Because the small company might be relatively simple to implement and the technical staff might be inexperienced with the database and software, it is possible that the technical staff will be on the critical path of the project. If the database administrator can't learn how to handle the production database by the time the users are ready to go live, you might need to hire some temporary help to enable the users to keep to the schedule. In addition, we often see small companies with just a single database administrator who might be working 60 or more hours per week. They feel they can afford to have more DBAs as employees, but they don't know how to establish the right ratio of support staff to user requirements. These companies can burn out a DBA quickly and then have to deal with the problem of replacing an important skill.

UNIT V

SOFTWARE PROJECT MANAGEMENT

Measures and Measurements

- Software measurement is concerned with deriving a numeric value for an attribute of a software product or process.
- This allows for objective comparisons between techniques and processes.
- Although some companies have introduced measurement programmes, most organisations still don't make systematic use of software measurement.
- There are few established standards in this area.

Software metric

- Any type of measurement which relates to a software system, process or related documentation
 - Lines of code in a program, the Fog index, number of person-days required to develop a component.
- Allow the software and the software process to be quantified.
- May be used to predict product attributes or to control the software process.
- Product metrics can be used for general predictions or to identify anomalous components.

Predictor and control metrics

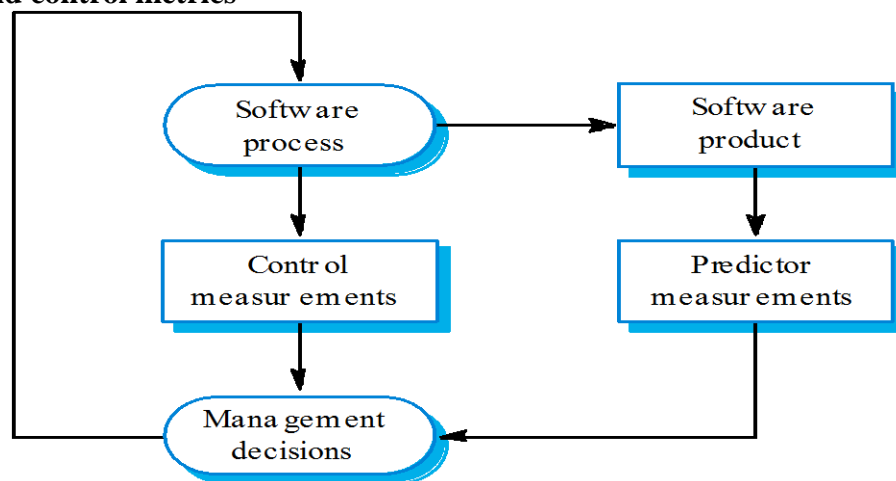

Metrics assumptions

- A software property can be measured.
- The relationship exists between what we can measure and what we want to know. We can only measure internal attributes but are often more interested in external software attributes.
- This relationship has been formalised and validated.
- It may be difficult to relate what can be measured to desirable external quality attributes.

Internal and external attributes

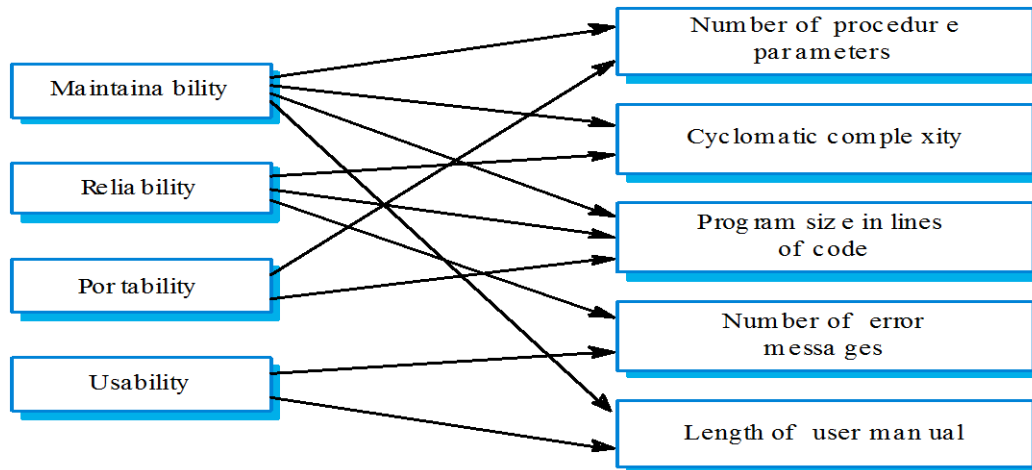

The measurement process

- A software measurement process may be part of a quality control process.
- Data collected during this process should be maintained as an organisational resource.
- Once a measurement database has been established, comparisons across projects become possible.

Product measurement process

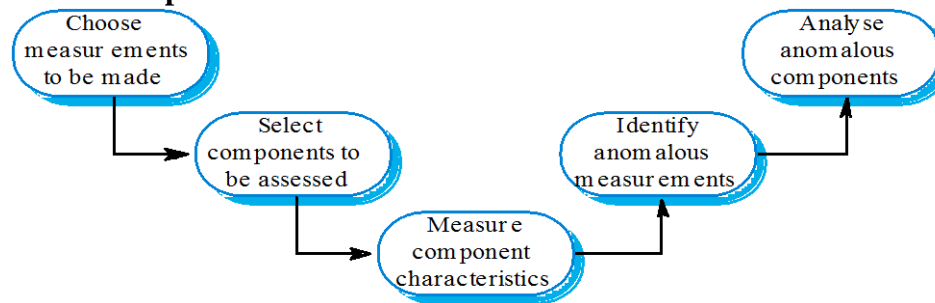

Data collection

- A metrics programme should be based on a set of product and process data.
- Data should be collected immediately (not in retrospect) and, if possible, automatically.
- Three types of automatic data collection
 - Static product analysis;
 - Dynamic product analysis;
 - Process data collation.

Data accuracy

- Don't collect unnecessary data
 - The questions to be answered should be decided in advance and the required data identified.
- Tell people why the data is being collected.
 - It should not be part of personnel evaluation.
- Don't rely on memory
 - Collect data when it is generated not after a project has finished.

Product metrics

- A quality metric should be a predictor of product quality.
- Classes of product metric
 - Dynamic metrics which are collected by measurements made of a program in execution;
 - Static metrics which are collected by measurements made of the system representations;
 - Dynamic metrics help assess efficiency and reliability; static metrics help assess complexity, understand ability and maintainability.

Dynamic and static metrics

- Dynamic metrics are closely related to software quality attributes
 - It is relatively easy to measure the response time of a system (performance attribute) or the number of failures (reliability attribute).
- Static metrics have an indirect relationship with quality attributes
 - You need to try and derive a relationship between these metrics and properties such as complexity, understandability and maintainability.

Software product metrics

Software metric	Description
Fan in/Fan-out	Fan-in is a measure of the number of functions or methods that call some other function or method (say X). Fan-out is the number of functions that are called by function X. A high value for fan-in means that X is tightly coupled to the rest of the design and changes to X will have extensive knock-on effects. A high value for fan-out suggests that the overall complexity of X may be high because of the complexity of the control logic needed to coordinate the called components.
Length of code	This is a measure of the size of a program. Generally, the larger the size of the code of a component, the more complex and error-prone that component is likely to be. Length of code has been shown to be one of the most reliable metrics for predicting error-proneness in components.
Cyclomatic complexity	This is a measure of the control complexity of a program. This control complexity may be related to program understandability. I discuss how to compute cyclomatic complexity in Chapter 22.
Length of identifiers	This is a measure of the average length of distinct identifiers in a program. The longer the identifiers, the more likely they are to be meaningful and hence the more understandable the program.
Depth of conditional nesting	This is a measure of the depth of nesting of if-statements in a program. Deeply nested if statements are hard to understand and are potentially error-prone.
Fog index	This is a measure of the average length of words and sentences in documents. The higher the value for the Fog index, the more difficult the document is to understand.

Object-oriented metrics

Object-oriented metric	Description
Depth of inheritance tree	This represents the number of discrete levels in the inheritance tree where sub-classes inherit attributes and operations (methods) from super-classes. The deeper the inheritance tree, the more complex the design. Many different object classes may have to be understood to understand the object classes at the leaves of the tree.
Method fan-in/fan-out	This is directly related to fan-in and fan-out as described above and means essentially the same thing. However, it may be appropriate to make a distinction between calls from other methods within the object and calls from external methods.
Weighted methods per class	This is the number of methods that are included in a class weighted by the complexity of each method. Therefore, a simple method may have a complexity of 1 and a large and complex method a much higher value. The larger the value for this metric, the more complex the object class. Complex objects are more likely to be more difficult to understand. They may not be logically cohesive so cannot be reused effectively as super-classes in an inheritance tree.
Number of overriding operations	This is the number of operations in a super-class that are overridden in a sub-class. A high value for this metric indicates that the super-class used may not be an appropriate parent for the sub-class.

Measurement analysis

- It is not always obvious what data means
 - Analysing collected data is very difficult.
- Professional statisticians should be consulted if available.
- Data analysis must take local circumstances into account.

Measurement surprises

- Reducing the number of faults in a program leads to an increased number of help desk calls
 - The program is now thought of as more reliable and so has a wider more diverse market. The percentage of users who call the help desk may have decreased but the total may increase;
 - A more reliable system is used in a different way from a system where users work around the faults. This leads to more help desk calls.

ZIPF's Law

- Zipf's Law as "the observation that frequency of occurrence of some event (P), as a function of the rank (i) when the rank is determined by the above frequency of occurrence, is a power-law function $P_i \sim 1/i^a$ with the exponent a close to unity (1)."

- Let P (a random variable) represented the frequency of occurrence of a keyword in a program listing.
- It applies to computer programs written in any modern computer language.
- Without empirical proof because it's an obvious finding, that any computer program written in any programming language has a power law distribution, i.e., some keywords are used more than others.
- Frequency of occurrence of events is inversely proportional to the rank in this frequency of occurrence.
- When both are plotted on a log scale, the graph is a straight line.
- we create entities that don't exist except in computer memory at run time; we create logic nodes that will never be tested because it's impossible to test every logic branch; we create information flows in quantities that are humanly impossible to analyze with a glance;
- Software application is the combination of keywords within the context of a solution and not their quantity used in a program; context is not a trivial task because the context of an application is attached to the problem being solved and every problem to solve is different and must have a specific program to solve it.
- Although a program could be syntactically correct, it doesn't mean that the algorithms implemented solve the problem at hand. What's more, a correct program can solve the wrong problem. Let's say we have the simple requirement of printing "Hello, World!" A syntactically correct solution in Java looks as follows:
- ```
Public class SayHello {
 public static void main(String[] args) {
 System.out.println("John Sena!");
 }
}
```
- This solution is obviously wrong because it doesn't solve the original requirement. This means that the context of the solution within the problem being solved needs to be determined to ensure its quality. In other words, we need to verify that the output matches the original requirement.
- Zip's Law can't even say too much about larger systems.

### **Software Cost Estimation**

#### **Software cost components**

- Hardware and software costs.
- Travel and training costs.
- Effort costs (the dominant factor in most projects)
  - The salaries of engineers involved in the project;
  - Social and insurance costs.
- Effort costs must take overheads into account
  - Costs of building, heating, lighting.
  - Costs of networking and communications.
  - Costs of shared facilities (e.g library, staff restaurant, etc.).

#### **Costing and pricing**

- Estimates are made to discover the cost, to the developer, of producing a software system.

- There is not a simple relationship between the development cost and the price charged to the customer.
- Broader organisational, economic, political and business considerations influence the price charged.

### **Software productivity**

- A measure of the rate at which individual engineers involved in software development produce software and associated documentation.
- Not quality-oriented although quality assurance is a factor in productivity assessment.
- Essentially, we want to measure useful functionality produced per time unit.

### **Productivity measures**

- Size related measures based on some output from the software process. This may be lines of delivered source code, object code instructions, etc.
- Function-related measures based on an estimate of the functionality of the delivered software. Function-points are the best known of this type of measure.

### **Measurement problems**

- Estimating the size of the measure (e.g. how many function points).
- Estimating the total number of programmer months that have elapsed.
- Estimating contractor productivity (e.g. documentation team) and incorporating this estimate in overall estimate.

### **Lines of code**

- The measure was first proposed when programs were typed on cards with one line per card;
- How does this correspond to statements as in Java which can span several lines or where there can be several statements on one line.

### **Productivity comparisons**

- The lower level the language, the more productive the programmer
  - The same functionality takes more code to implement in a lower-level language than in a high-level language.
- The more verbose the programmer, the higher the productivity
  - Measures of productivity based on lines of code suggest that programmers who write verbose code are more productive than programmers who write compact code.

## **Function Point model**

### **Function points**

- Based on a combination of program characteristics
  - external inputs and outputs;
  - user interactions;
  - external interfaces;
  - files used by the system.
- A weight is associated with each of these and the function point count is computed by multiplying each raw count by the weight and summing all values.

- The function point count is modified by complexity of the project
- FPs can be used to estimate LOC depending on the average number of LOC per FP for a given language
  - $LOC = AVC * \text{number of function points}$ ;
  - AVC is a language-dependent factor varying from 200-300 for assemble language to 2-40 for a 4GL;
- FPs are very subjective. They depend on the estimator
  - Automatic function-point counting is impossible.

### COCOMO model

- An empirical model based on project experience.
- Well-documented, 'independent' model which is not tied to a specific software vendor.
- Long history from initial version published in 1981 (COCOMO-81) through various instantiations to COCOMO 2.
- COCOMO 2 takes into account different approaches to software development, reuse, etc.

### COCOMO 81

| Project complexity | Formula                           | Description                                                                                                                              |
|--------------------|-----------------------------------|------------------------------------------------------------------------------------------------------------------------------------------|
| Simple             | $PM = 2.4 (KDSI)^{1.05} \times M$ | Well-understood applications developed by small teams.                                                                                   |
| Moderate           | $PM = 3.0 (KDSI)^{1.12} \times M$ | More complex projects where team members may have limited experience of related systems.                                                 |
| Embedded           | $PM = 3.6 (KDSI)^{1.20} \times M$ | Complex projects where the software is part of a strongly coupled complex of hardware, software, regulations and operational procedures. |

### COCOMO 2

- COCOMO 81 was developed with the assumption that a waterfall process would be used and that all software would be developed from scratch.
- Since its formulation, there have been many changes in software engineering practice and COCOMO 2 is designed to accommodate different approaches to software development.

### COCOMO 2 models

- COCOMO 2 incorporates a range of sub-models that produce increasingly detailed software estimates.
- The sub-models in COCOMO 2 are:
  - Application composition model. Used when software is composed from existing parts.
  - Early design model. Used when requirements are available but design has not yet started.
  - Reuse model. Used to compute the effort of integrating reusable components.

- Post-architecture model. Used once the system architecture has been designed and more information about the system is available.

### Use of COCOMO 2 models

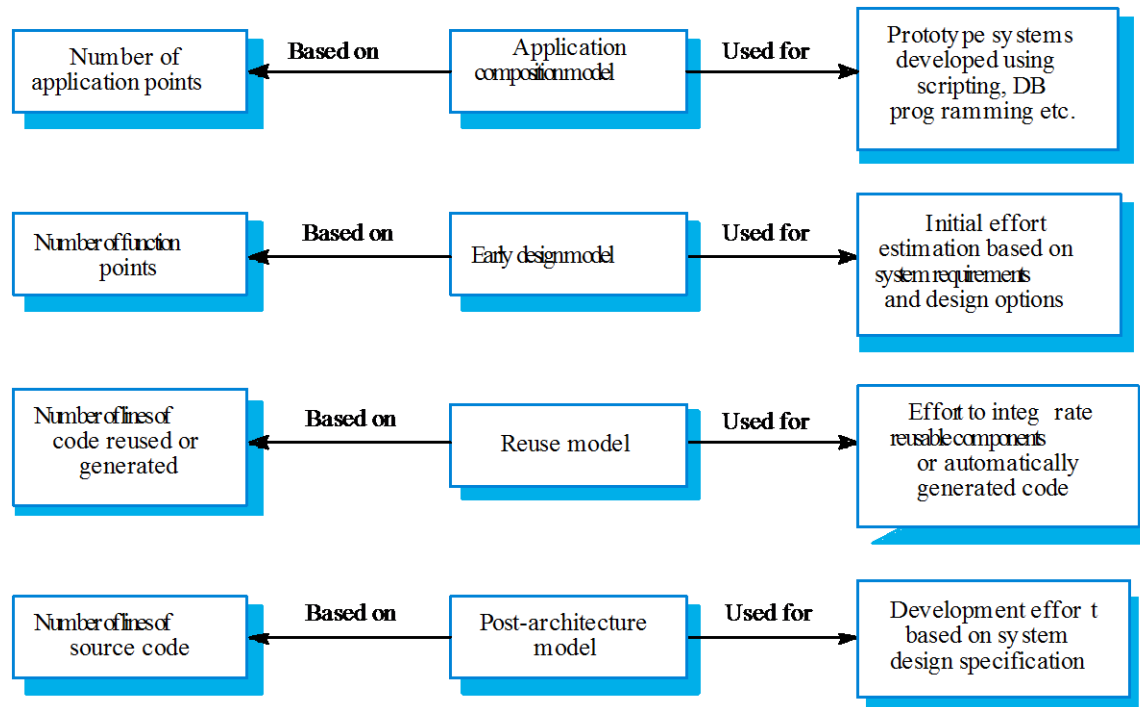

### Application composition model

- Supports prototyping projects and projects where there is extensive reuse.
- Based on standard estimates of developer productivity in application (object) points/month.
- Takes CASE tool use into account.
- Formula is
  - $PM = (NAP \cdot (1 - \%reuse/100)) / PROD$
  - PM is the effort in person-months, NAP is the number of application points and PROD is the productivity.

### Early design model

- Estimates can be made after the requirements have been agreed.
- Based on a standard formula for algorithmic models
  - $PM = A \cdot Size^B \cdot M$  where
  - $M = PERS \cdot RCPX \cdot RUSE \cdot PDIF \cdot PREX \cdot FCIL \cdot SCED$ ;
  - $A = 2.94$  in initial calibration, Size in KLOC, B varies from 1.1 to 1.24 depending on novelty of the project, development flexibility, risk management approaches and the process maturity.

### Multipliers

- Multipliers reflect the capability of the developers, the non-functional requirements, the familiarity with the development platform, etc.
  - RCPX - product reliability and complexity;

- RUSE - the reuse required;
- PDIF - platform difficulty;
- PREX - personnel experience;
- PERS - personnel capability;
- SCED - required schedule;
- FCIL - the team support facilities.

### The reuse model

- Takes into account black-box code that is reused without change and code that has to be adapted to integrate it with new code.
- There are two versions:
  - Black-box reuse where code is not modified. An effort estimate (PM) is computed.
  - White-box reuse where code is modified. A size estimate equivalent to the number of lines of new source code is computed. This then adjusts the size estimate for new code.

### Reuse model estimates

- For generated code:
  - $PM = (ASLOC * AT/100)/ATPROD$
  - ASLOC is the number of lines of generated code
  - AT is the percentage of code automatically generated.
  - ATPROD is the productivity of engineers in integrating this code.
- When code has to be understood and integrated:
  - $ESLOC = ASLOC * (1-AT/100) * AAM$ .
  - ASLOC and AT as before.
  - AAM is the adaptation adjustment multiplier computed from the costs of changing the reused code, the costs of understanding how to integrate the code and the costs of reuse decision making.

### Post-architecture level

- Uses the same formula as the early design model but with 17 rather than 7 associated multipliers.
- The code size is estimated as:
  - Number of lines of new code to be developed;
  - Estimate of equivalent number of lines of new code computed using the reuse model;
  - An estimate of the number of lines of code that have to be modified according to requirements changes.

### The exponent term

- This depends on 5 scale factors (see next slide). Their sum/100 is added to 1.01
- A company takes on a project in a new domain. The client has not defined the process to be used and has not allowed time for risk analysis. The company has a CMM level 2 rating.
  - Precedentness - new project (4)
  - Development flexibility - no client involvement - Very high (1)
  - Architecture/risk resolution - No risk analysis - V. Low .(5)
  - Team cohesion - new team - nominal (3)
  - Process maturity - some control - nominal (3)

- Scale factor is therefore 1.17.

### Multipliers

- Product attributes
  - Concerned with required characteristics of the software product being developed.
- Computer attributes
  - Constraints imposed on the software by the hardware platform.
- Personnel attributes
  - Multipliers that take the experience and capabilities of the people working on the project into account.
- Project attributes
  - Concerned with the particular characteristics of the software development project.

### Delphi method

The Delphi method is a systematic, interactive forecasting method which relies on a panel of experts. The experts answer questionnaires in two or more rounds. After each round, a facilitator provides an anonymous summary of the experts' forecasts from the previous round as well as the reasons they provided for their judgments. Thus, experts are encouraged to revise their earlier answers in light of the replies of other members of their panel. It is believed that during this process the range of the answers will decrease and the group will converge towards the "correct" answer. Finally, the process is stopped after a pre-defined stop criterion (e.g. number of rounds, achievement of consensus, stability of results) and the mean or median scores of the final rounds determine the results.

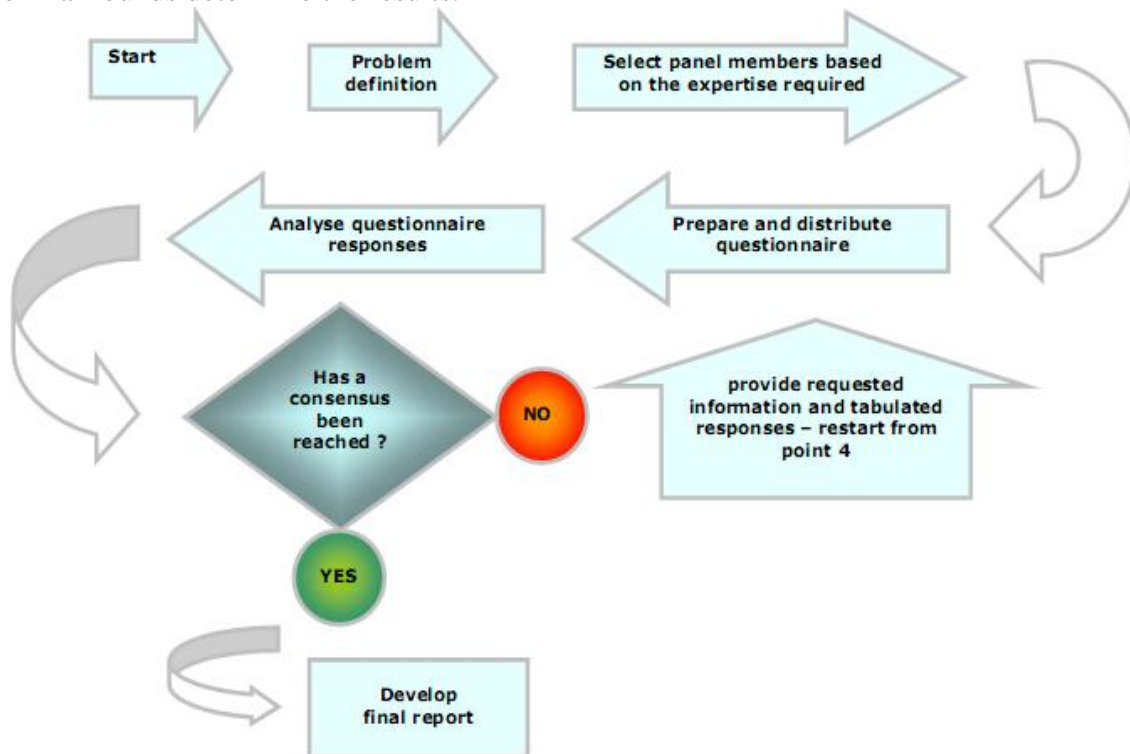

The Delphi Technique is an essential project management technique that refers to an information gathering technique in which the opinions of those whose opinions are most valuable, traditionally industry experts, is solicited, with the ultimate hope and goal of attaining a consensus. Typically, the polling of these industry experts is done on an anonymous basis, in hopes of attaining opinions that are unfettered by fears or identifiability. The experts are presented with a series of questions in regards to the project, which is typically, but not always, presented to the expert by a third-party facilitator, in hopes of eliciting new ideas regarding specific project points. The responses from all experts are typically combined in the form of an overall summary, which is then provided to the experts for a review and for the opportunity to make further comments. This process typically results in consensus within a number of rounds, and this technique typically helps minimize bias, and minimizes the possibility that any one person can have too much influence on the outcomes.

### **Key characteristics**

The following key characteristics of the Delphi method help the participants to focus on the issues at hand and separate Delphi from other methodologies:

- **Structuring of information flow**

The initial contributions from the experts are collected in the form of answers to questionnaires and their comments to these answers. The panel director controls the interactions among the participants by processing the information and filtering out irrelevant content. This avoids the negative effects of face-to-face panel discussions and solves the usual problems of group dynamics.

- **Regular feedback**

Participants comment on their own forecasts, the responses of others and on the progress of the panel as a whole. At any moment they can revise their earlier statements. While in regular group meetings participants tend to stick to previously stated opinions and often conform too much to group leader, the Delphi method prevents it.

- **Anonymity of the participants**

Usually all participants maintain anonymity. Their identity is not revealed even after the completion of the final report. This stops them from dominating others in the process using their authority or personality, frees them to some extent from their personal biases, minimizes the "bandwagon effect" or "halo effect", allows them to freely express their opinions, and encourages open critique and admitting errors by revising earlier judgments.

The first step is to found a steering committee (if you need one) and a management team with sufficient capacities for the process. Then expert panels to prepare and formulate the statements are helpful unless it is decided to let that be done by the management team. The whole procedure has to be fixed in advance: Do you need panel meetings or do the teams work virtually. Is the questionnaire an electronic or a paper one? This means, that logistics (from Internet programming to typing the results from the paper versions) have to be organised. Will there be follow-up work-shops, interviews, presentations? If yes, these also have to be organised and pre-pared. Printing of brochures, leaflets, questionnaire, reports have also be considered. The last organisational point is the interface with the financing organisation if this is different from the management team.

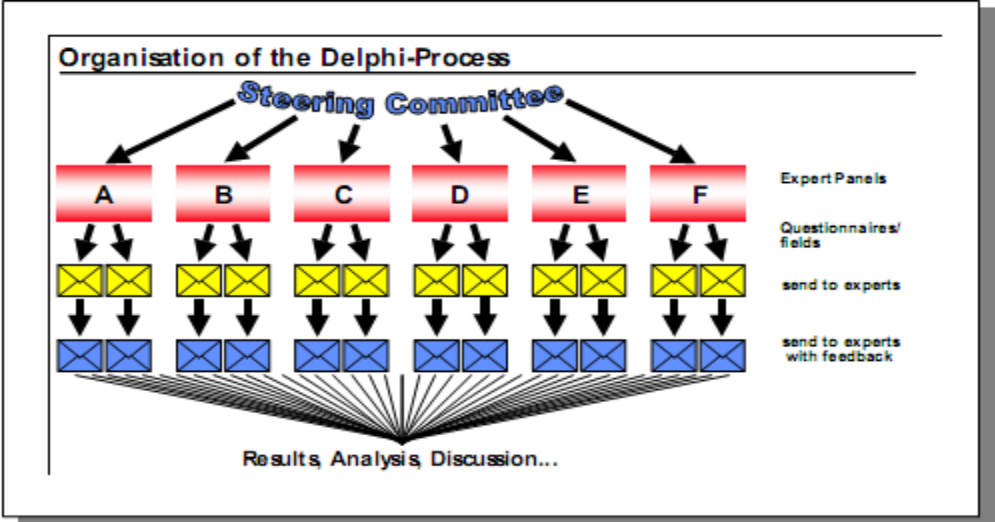

### Scheduling

#### Scheduling Principles

- compartmentalization—define distinct tasks
- interdependency—indicate task interrelationship
- effort validation—be sure resources are available
- defined responsibilities—people must be assigned
- defined outcomes—each task must have an output
- defined milestones—review for quality

#### Effort and Delivery Time

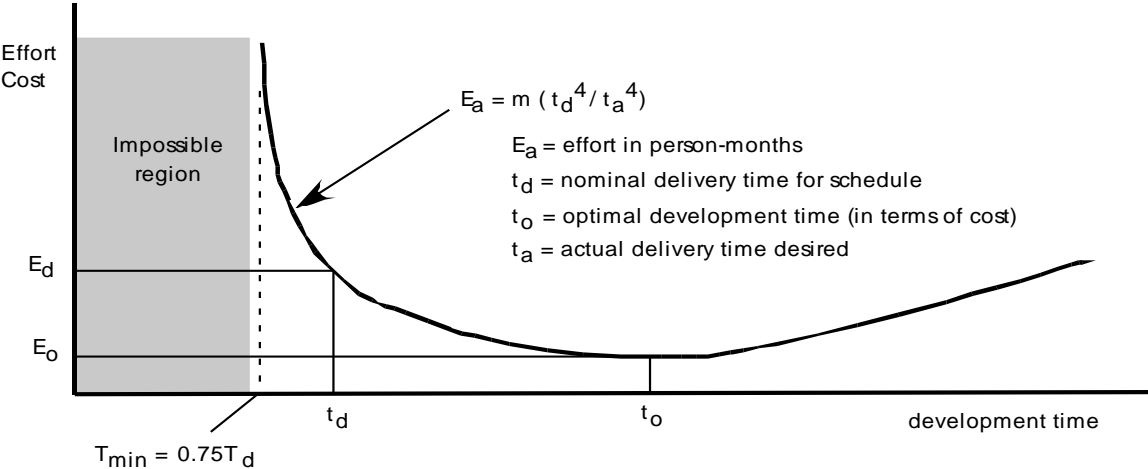

#### Empirical Relationship: P vs E

Given Putnam's Software Equation (5-3),

$$E = L^3 / (P^3 t^4)$$



Consider a project estimated at 33 KLOC, 12 person-years of effort, with a P of 10K, the completion time would be 1.3 years

If deadline can be extended to 1.75 years,

$$E = L^3 / (P^3 t^4) \approx 3.8 \text{ p-years vs } 12 \text{ p-years}$$

**Timeline Charts**

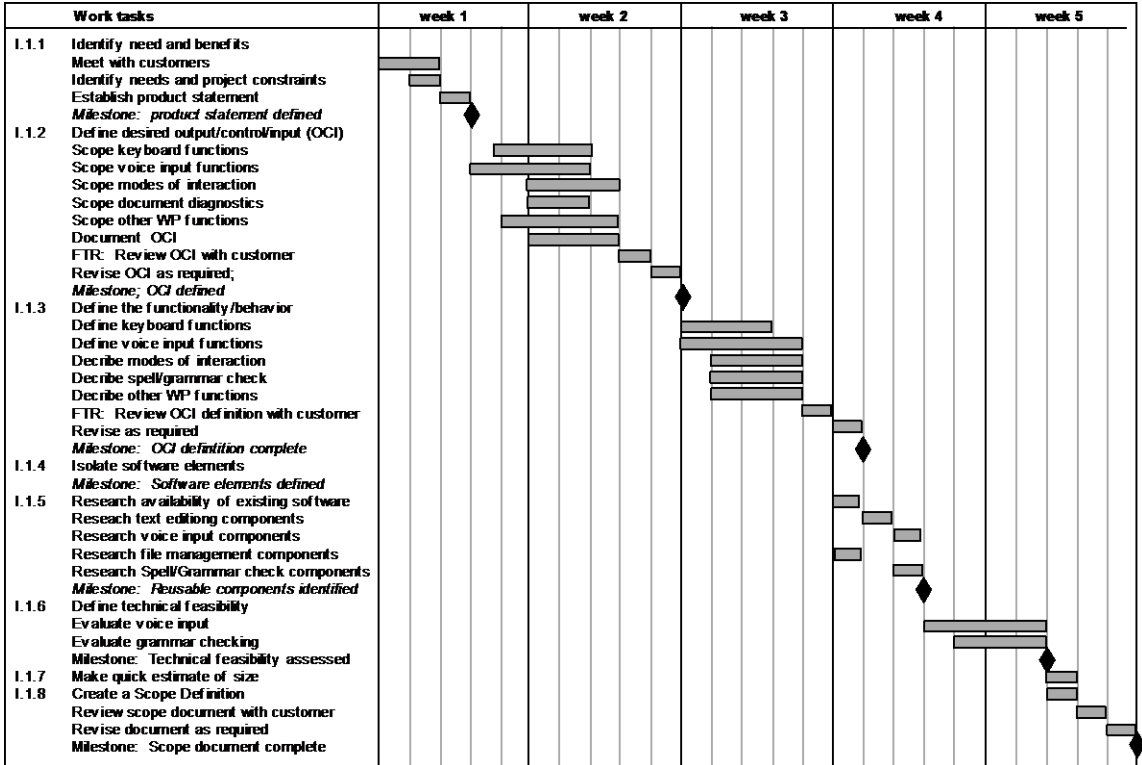

**Effort Allocation**

- “front end” activities
  - customer communication
  - analysis
  - design
  - review and modification
- construction activities
  - coding or code generation
- testing and installation
  - unit, integration
  - white-box, black box
  - regression

**Defining Task Sets**

- determine type of project
  - concept development, new application development, application enhancement, application maintenance, and reengineering projects

- assess the degree of rigor required
- identify adaptation criteria
- select appropriate software engineering tasks

### Earned Value Analysis

- Earned value
  - is a measure of progress
  - enables us to assess the “percent of completeness” of a project using quantitative analysis rather than rely on a gut feeling
  - “provides accurate and reliable readings of performance from as early as 15 percent into the project.”

### Computing Earned Value

#### Budgeted cost of work scheduled (BCWS)

- The *budgeted cost of work scheduled* (BCWS) is determined for each work task represented in the schedule.
  - $BCWS_i$  is the effort planned for work task  $i$ .
  - To determine progress at a given point along the project schedule, the value of BCWS is the sum of the  $BCWS_i$  values for all work tasks that should have been completed by that point in time on the project schedule.
- The BCWS values for all work tasks are summed to derive the *budget at completion*, BAC. Hence,
- $$BAC = \sum (BCWS_k) \text{ for all tasks } k$$

#### Budgeted cost of work performed (BCWP)

- Next, the value for *budgeted cost of work performed* (BCWP) is computed.
  - The value for BCWP is the sum of the BCWS values for all work tasks that have actually been completed by a point in time on the project schedule.
- “the distinction between the BCWS and the BCWP is that the former represents the budget of the activities that were planned to be completed and the latter represents the budget of the activities that actually were completed.”
- Given values for BCWS, BAC, and BCWP, important progress indicators can be computed:
  - Schedule performance index,  $SPI = BCWP/BCWS$
  - Schedule variance,  $SV = BCWP - BCWS$
  - SPI is an indication of the efficiency with which the project is utilizing scheduled resources.

#### Actual cost of work performed, ACWP

- Percent scheduled for completion =  $BCWS/BAC$ 
  - provides an indication of the percentage of work that should have been completed by time  $t$ .
- Percent complete =  $BCWP/BAC$ 
  - provides a quantitative indication of the percent of completeness of the project at a given point in time,  $t$ .

- *Actual cost of work performed, ACWP*, is the sum of the effort actually expended on work tasks that have been completed by a point in time on the project schedule. It is then possible to compute
  - Cost performance index,  $CPI = BCWP/ACWP$
  - Cost variance,  $CV = BCWP - ACWP$

### Problem

- Assume you are a software project manager and that you've been asked to computer earned value statistics for a small software project. The project has 56 planned work tasks that are estimated to require 582 person-days to complete. At the time that you've been asked to do the earned value analysis, 12 tasks have been completed. However, the project schedule indicates that 15 tasks should have been completed. The following scheduling data (in person-days) are available:

| Task | Planned Effort | Actual Effort |
|------|----------------|---------------|
| • 1  | 12             | 12.5          |
| • 2  | 15             | 11            |
| • 3  | 13             | 17            |
| • 4  | 8              | 9.5           |
| • 5  | 9.5            | 9.0           |
| • 6  | 18             | 19            |
| • 7  | 10             | 10            |
| • 8  | 4              | 4.5           |
| • 9  | 12             | 10            |
| • 10 | 6              | 6.5           |
| • 11 | 5              | 4             |
| • 12 | 14             | 14.5          |
| • 13 | 16             |               |
| • 14 | 6              |               |
| • 15 | 8              |               |

### Error Tracking

- Schedule Tracking
  - conduct periodic project status meetings in which each team member reports progress and problems.
  - evaluate the results of all reviews conducted throughout the software engineering process.
  - determine whether formal project milestones (diamonds in previous slide) have been accomplished by the scheduled date.
  - compare actual start-date to planned start-date for each project task listed in the resource table
  - meet informally with practitioners to obtain their subjective assessment of progress to date and problems on the horizon.
  - use earned value analysis to assess progress quantitatively.
- Progress on an OO Project-I

- Technical milestone: OO analysis completed
  - All classes and the class hierarchy have been defined and reviewed.
  - Class attributes and operations associated with a class have been defined and reviewed.
  - Class relationships (Chapter 8) have been established and reviewed.
  - A behavioral model (Chapter 8) has been created and reviewed.
  - Reusable classes have been noted.
- Technical milestone: OO design completed
  - The set of subsystems (Chapter 9) has been defined and reviewed.
  - Classes are allocated to subsystems and reviewed.
  - Task allocation has been established and reviewed.
  - Responsibilities and collaborations (Chapter 9) have been identified.
  - Attributes and operations have been designed and reviewed.
  - The communication model has been created and reviewed.
- Progress on an OO Project-II
- Technical milestone: OO programming completed
  - Each new class has been implemented in code from the design model.
  - Extracted classes (from a reuse library) have been implemented.
  - Prototype or increment has been built.
- Technical milestone: OO testing
  - The correctness and completeness of OO analysis and design models has been reviewed.
  - A class-responsibility-collaboration network (Chapter 8) has been developed and reviewed.
  - Test cases are designed and class-level tests (Chapter 14) have been conducted for each class.
  - Test cases are designed and cluster testing (Chapter 14) is completed and the classes are integrated.
  - System level tests have been completed.

### Software Configuration Management

- Configuration management is all about change control.
- Every software engineer has to be concerned with how changes made to work products are tracked and propagated throughout a project.
- To ensure quality is maintained the change process must be audited.

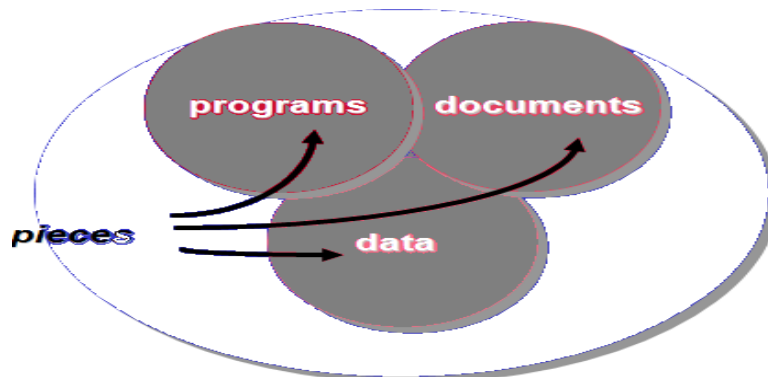

### Software Configuration categories

- Computer programs
  - source
  - executable
- Documentation
  - Technical / user
- Data
  - contained within the program
  - external data (e.g. files and databases)

### Elements of SCM

- Component element
  - Tools coupled with file management
- Process element
  - Procedures define change management
- Construction element
  - Automate construction of software
- Human elements
  - Give guidance for activities and process features

### Baselines

- A work product becomes a baseline only after it is reviewed and approved.
- Before baseline – changes informal
- Once a baseline is established each change request must be evaluated and verified before it is processed.

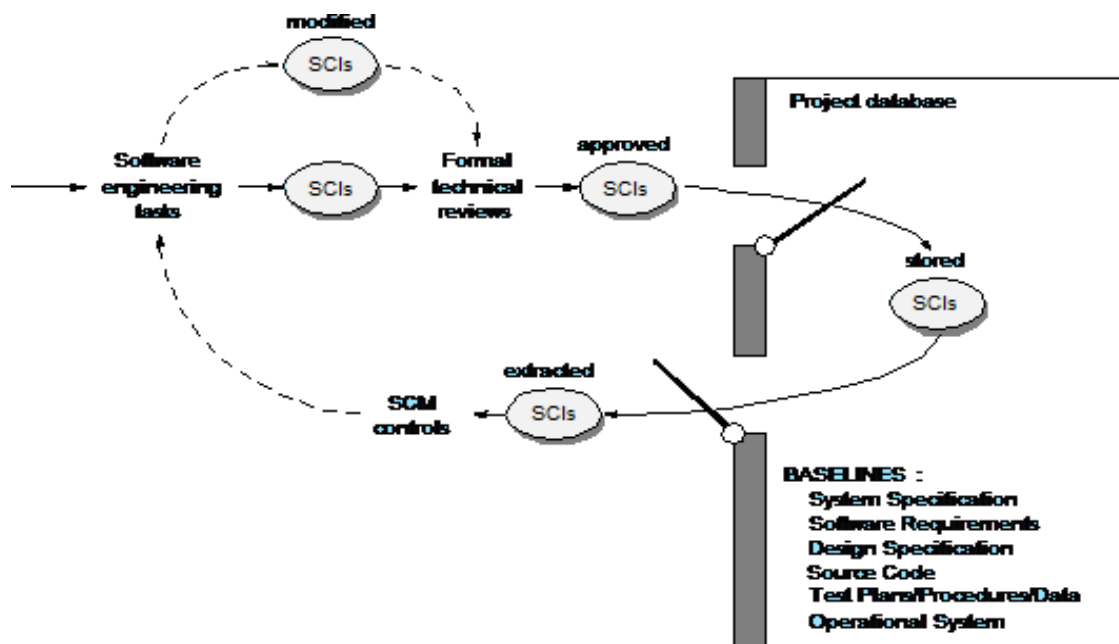

## Software Configuration Items

- SCI
- Document
- Test cases
- Program component
- Editors, compilers, browsers
  - Used to produce documentation.

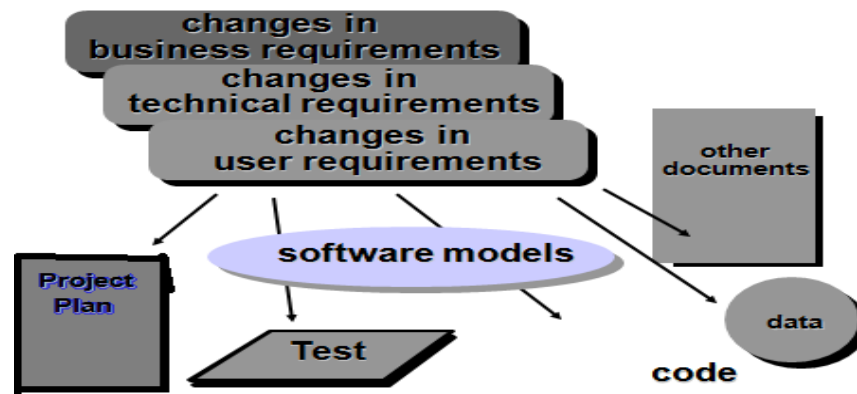

## Configuration Management process

- Identification
  - tracking changes to multiple SCI versions
- Version control
  - controlling changes before and after customer release
- Change control
  - authority to approve and prioritize changes
- Configuration auditing
  - ensure changes are made properly
- Reporting
  - tell others about changes made

### Program evolution dynamics

- Program evolution dynamics is the study of the processes of system change.
- After major empirical studies, Lehman and Belady proposed that there were a number of 'laws' which applied to all systems as they evolved.
- There are sensible observations rather than laws. They are applicable to large systems developed by large organisations. Perhaps less applicable in other cases.

## Importance of evolution

- Organizations have huge investments in their software systems - they are critical business assets.
- To maintain the value of these assets to the business, they must be changed and updated.
- The majority of the software budget in large companies is devoted to evolving existing software rather than developing new software.

### Software change

- Software change is inevitable
  - New requirements emerge when the software is used;
  - The business environment changes;
  - Errors must be repaired;
  - New computers and equipment is added to the system;
  - The performance or reliability of the system may have to be improved.
- A key problem for organisations is implementing and managing change to their existing software systems.

### Lehman's laws

| Law                         | Description                                                                                                                                                                                 |
|-----------------------------|---------------------------------------------------------------------------------------------------------------------------------------------------------------------------------------------|
| Continuing change           | A program that is used in a real-world environment necessarily must change or become progressively less useful in that environment.                                                         |
| Increasing complexity       | As an evolving program changes, its structure tends to become more complex. Extra resources must be devoted to <u>preserving and simplifying</u> the structure.                             |
| Large program evolution     | Program evolution is a self-regulating process. System attributes such as size, time between releases and the number of reported errors is approximately invariant for each system release. |
| Organisational stability    | Over a program's lifetime, its rate of development is approximately constant and independent of the resources devoted to system development.                                                |
| Conservation of familiarity | Over the lifetime of a system, the incremental change in each release is approximately constant.                                                                                            |
| Continuing growth           | The functionality offered by systems has to continually increase to maintain user satisfaction.                                                                                             |
| Declining quality           | The quality of systems will appear to be declining unless they are adapted to changes in their operational environment.                                                                     |
| Feedback system             | Evolution processes incorporate multi-agent, multi-loop feedback systems and you have to treat them as feedback systems to achieve significant product improvement.                         |

### Applicability of Lehman's laws

- Lehman's laws seem to be generally applicable to large, tailored systems developed by large organisations.
  - Confirmed in more recent work by Lehman on the FEAST project (see further reading on book website).
- It is not clear how they should be modified for
  - Shrink-wrapped software products;
  - Systems that incorporate a significant number of COTS components;

- Small organisations;
- Medium sized systems.

### Software maintenance

- Modifying a program after it has been put into use or delivered.
- Maintenance does not normally involve major changes to the system's architecture.
- Changes are implemented by modifying existing components and adding new components to the system.
- Maintenance is inevitable
- The system requirements are likely to change while the system is being developed because the environment is changing. Therefore a delivered system won't meet its requirements!
- Systems are tightly coupled with their environment. When a system is installed in an environment it changes that environment and therefore changes the system requirements.
- Systems MUST be maintained therefore if they are to remain useful in an environment.

### Types of maintenance

- Maintenance to repair software faults
  - Code ,design and requirement errors
  - Code & design cheap. Requirements most expensive.
- Maintenance to adapt software to a different operating environment
  - Changing a system's hardware and other support so that it operates in a different environment (computer, OS, etc.) from its initial implementation.
- Maintenance to add to or modify the system's functionality
  - Modifying the system to satisfy new requirements for org or business change.

### Distribution of maintenance effort

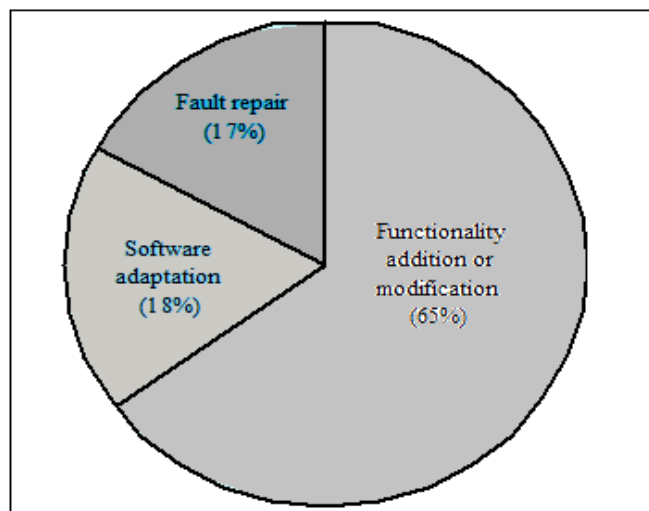

### Maintenance costs

- Usually greater than development costs (2\* to 100\* depending on the application).



- Affected by both technical and non-technical factors.
- Increases as software is maintained. Maintenance corrupts the software structure so makes further maintenance more difficult.
- Ageing software can have high support costs (e.g. old languages, compilers etc.).

### Development/maintenance costs

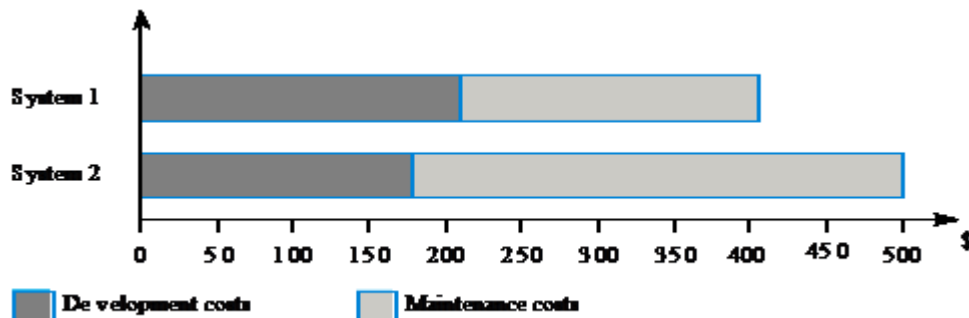

### Maintenance cost factors

- Team stability
  - Maintenance costs are reduced if the same staff are involved with them for some time.
- Contractual responsibility
  - The developers of a system may have no contractual responsibility for maintenance so there is no incentive to design for future change.
- Staff skills
  - Maintenance staff are often inexperienced and have limited domain knowledge.
- Program age and structure
  - As programs age, their structure is degraded and they become harder to understand and change.

### Maintenance prediction

- Maintenance prediction is concerned with assessing which parts of the system may cause problems and have high maintenance costs
  - Change acceptance depends on the maintainability of the components affected by the change;
  - Implementing changes degrades the system structure and reduces its maintainability;
  - Maintenance costs depend on the number of changes and costs of change depend on maintainability.

### Change prediction

- Predicting the number of changes requires an understanding of the relationships between a system and its environment.
- Tightly coupled systems require changes whenever the environment is changed.

- Factors influencing this relationship are
  - Number and complexity of system interfaces;
  - Number of inherently volatile system requirements;
  - The business processes where the system is used.

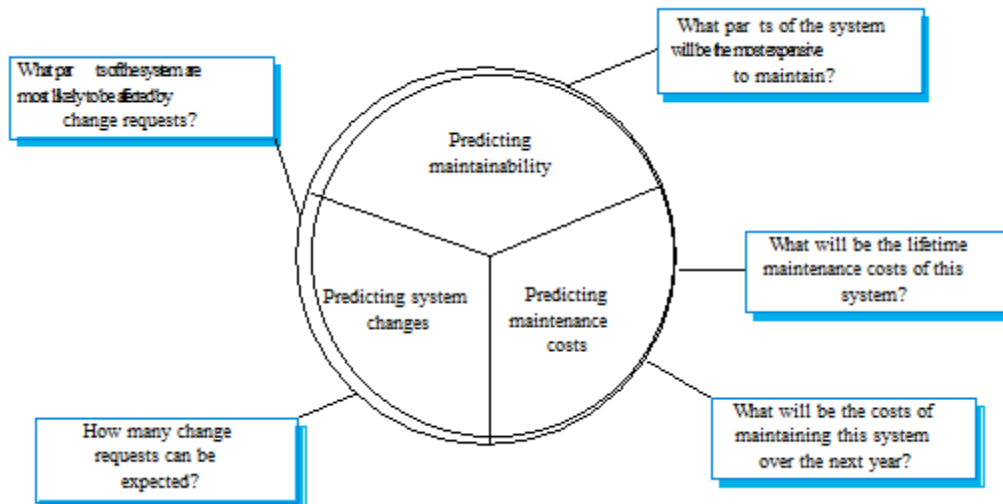

### Complexity metrics

- Predictions of maintainability can be made by assessing the complexity of system components.
- Studies have shown that most maintenance effort is spent on a relatively small number of system components of complex system.
- Reduce maintenance cost – replace complex components with simple alternatives.
- Complexity depends on
  - Complexity of control structures;
  - Complexity of data structures;
  - Object, method (procedure) and module size.

### Process metrics

- Process measurements may be used to assess maintainability
  - Number of requests for corrective maintenance;
  - Average time required for impact analysis;
  - Average time taken to implement a change request;
  - Number of outstanding change requests.
- If any or all of these is increasing, this may indicate a decline in maintainability.
- COCOMO2 model maintenance = understand existing code + develop new code.

### Project management

#### Objectives

- To explain the main tasks undertaken by project managers
- To introduce software project management and to describe its distinctive characteristics
- To discuss project planning and the planning process

- To show how graphical schedule representations are used by project management
- To discuss the notion of risks and the risk management process Software project management
- Concerned with activities involved in ensuring that software is delivered on time and on schedule and in accordance with the requirements of the organisations developing and procuring the software.
- Project management is needed because software development is always subject to budget and schedule constraints that are set by the organisation developing the software.

### Project planning

- Probably the most time-consuming project management activity.
- Continuous activity from initial concept through to system delivery. Plans must be regularly revised as new information becomes available.
- Various different types of plan may be developed to support the main software project plan that is concerned with schedule and budget.

### Types of project plan

| Plan                          | Description                                                                                 |
|-------------------------------|---------------------------------------------------------------------------------------------|
| Quality plan                  | Describes the quality procedures and standards that will be used in a project.              |
| Validation plan               | Describes the approach, resources and schedule used for system validation.                  |
| Configuration management Plan | Describes the configuration management procedures and structures to be used.                |
| Maintenance plan              | Predicts the maintenance requirements of the system, maintenance costs and effort required. |
| Development plan.             | Describes how the skills and experience of the project team members will be developed.      |

### Project planning process

Establish the project constraints(delivery date, staff, budget)

Make initial assessments of the project parameters (structure, size)

Define project milestones and deliverables

while project has not been completed or cancelled loop

    Draw up project schedule

    Initiate activities according to schedule

    Wait ( for a while )

    Review project progress

    Revise estimates of project parameters

    Update the project schedule

    Re-negotiate project constraints and deliverables

    if ( problems arise ) then

        Initiate technical review and possible revision

    end if

end loop

## project plan

The project plan sets out:

- resources available to the project
- work breakdown
- schedule for the work.

## Project plan structure

- Introduction – objective, budget, time
- Project organisation. – roles of people
- Risk analysis. – arising, reduction
- Hardware and software resource requirements.
- Work breakdown. – break project to activity, milestone
- Project schedule. – time, allocation of people
- Monitoring and reporting mechanisms.

## Milestones and deliverables

- Milestones are the end-point of a process activity.- report presented to management
- Deliverables are project results delivered to customers.
  - milestones need not be deliverables. May be used by project managers. – not to customers
- The waterfall process allows for the straight forward definition of progress milestones.

## Milestones in requirement process

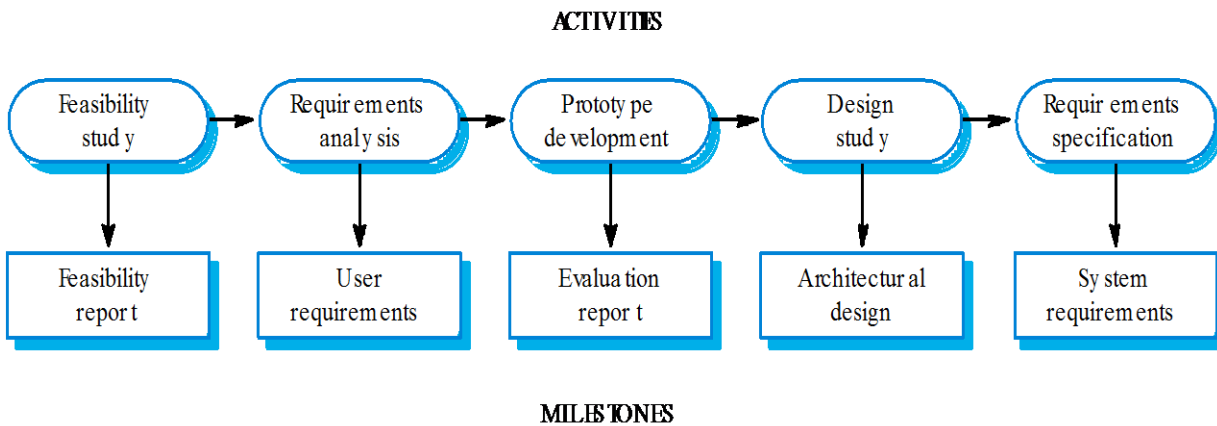

## Project scheduling

- Split project into tasks and estimate time and resources required to complete each task.
- Organize tasks concurrently to make optimal use of workforce.
- Minimize task dependencies to avoid delays caused by one task waiting for another to complete.
- Dependent on project managers intuition and experience.

## The project scheduling process

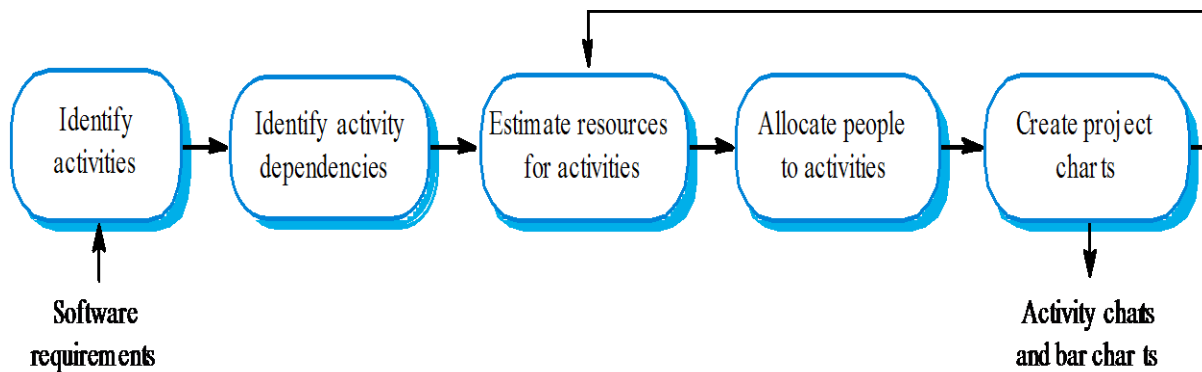

## Scheduling problems

- Estimating the difficulty of problems and hence the cost of developing a solution is hard.
- Productivity is not proportional to the number of people working on a task.
- Adding people to a late project makes it later because of communication overheads.
- The unexpected always happens. Always allow contingency in planning.

## Bar charts and activity networks

- Graphical notations used to illustrate the project schedule.
- Show project breakdown into tasks. Tasks should not be too small. They should take about a week or two.
- Activity charts show task dependencies and the critical path.
- Bar charts show schedule against calendar time.

## Task durations and dependencies

| Activity | Duration (days) | Dependencies |
|----------|-----------------|--------------|
| T1       | 8               |              |
| T2       | 15              |              |
| T3       | 15              | T1 (M1)      |
| T4       | 10              |              |
| T5       | 10              | T2, T4 (M2)  |
| T6       | 5               | T1, T2 (M3)  |
| T7       | 20              | T1 (M1)      |
| T8       | 25              | T4 (M5)      |
| T9       | 15              | T3, T6 (M4)  |
| T10      | 15              | T5, T7 (M7)  |
| T11      | 7               | T9 (M6)      |
| T12      | 10              | T11 (M8)     |

Activity network

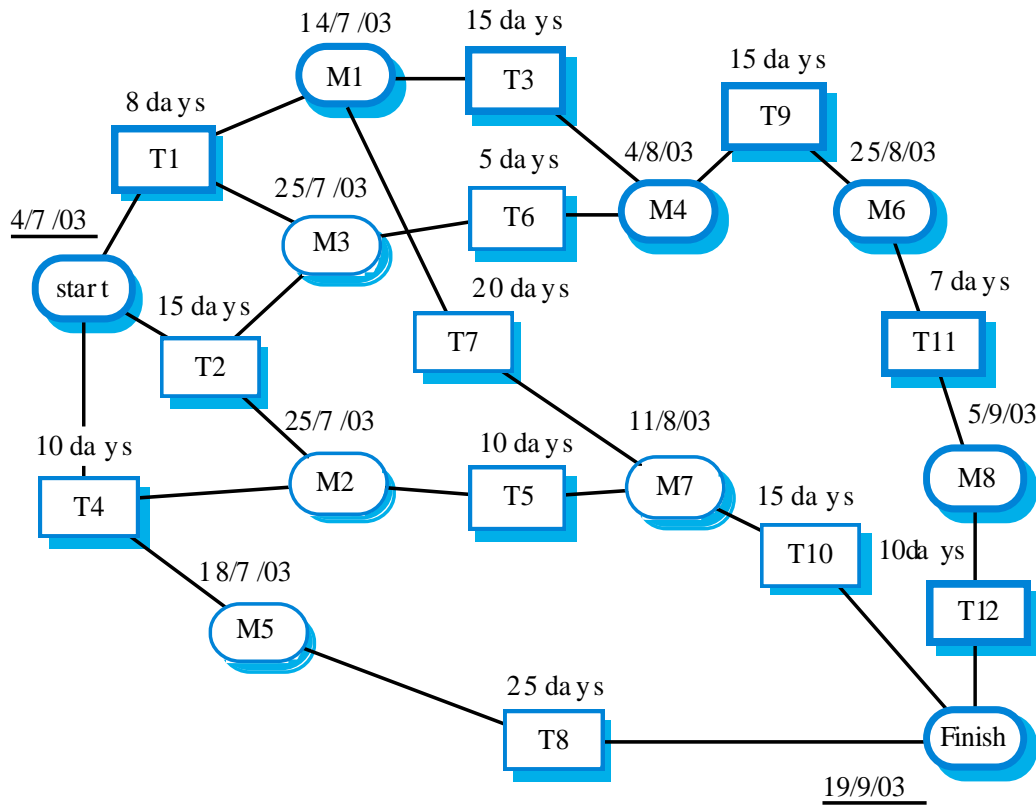

Activity timeline

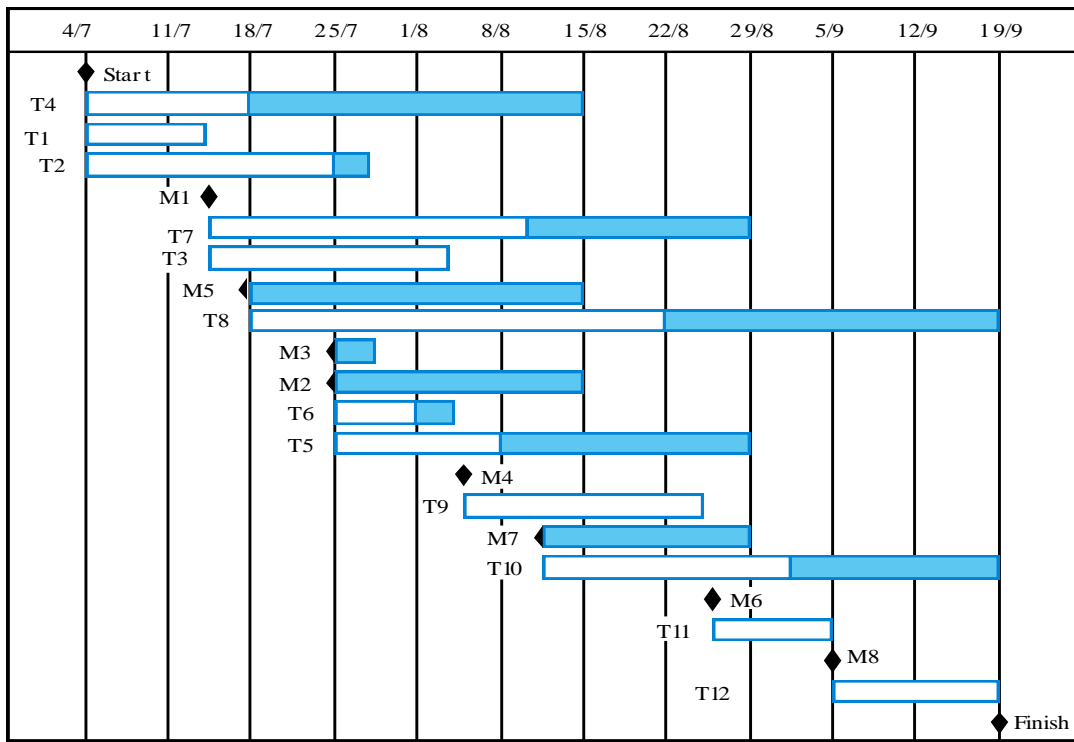

## Staff allocation

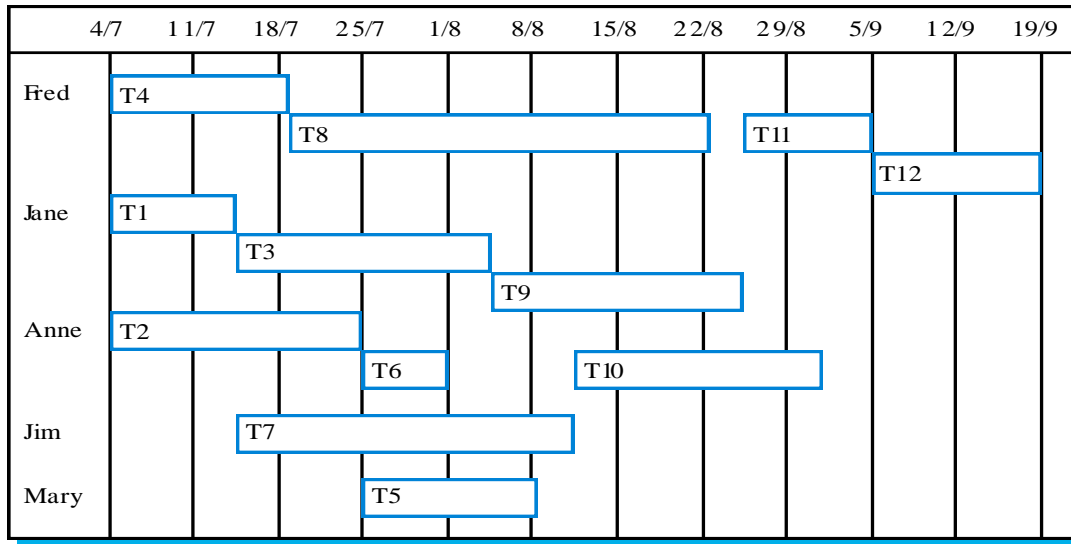

## Risk management

- Risk management - identifying risks and drawing up plans to minimise their effect on a project.
- A risk is a probability that some adverse circumstance will occur
  - Project risks : affect schedule or resources. eg: loss of experienced designer.
  - Product risks: affect the quality or performance of the software being developed. eg: failure of purchased component.
  - Business risks : affect organisation developing software. Eg: competitor introducing new product.

## Software risks

| Risk                        | Affects             | Description                                                                             |
|-----------------------------|---------------------|-----------------------------------------------------------------------------------------|
| Staff turnover              | Project             | Experienced staff will leave the project before it is finished.                         |
| Management change           | Project             | There will be a change of organisational management with different priorities.          |
| Hardware unavailability     | Project             | Hardware that is essential for the project will not be delivered on schedule.           |
| Requirements change         | Project and product | There will be a larger number of changes to the requirements than anticipated.          |
| Specification delays        | Project and product | Specifications of essential interfaces are not available on schedule                    |
| Size underestimate          | Project and product | The size of the system has been underestimated.                                         |
| CASE tool under-performance | Product             | CASE tools which support the project do not perform as anticipated                      |
| Technology change           | Business            | The underlying technology on which the system is built is superseded by new technology. |
| Product competition         | Business            | A competitive product is marketed before the system is completed.                       |

### Risk management process

- Risk identification
  - Identify project, product and business risks;
- Risk analysis
  - Assess the likelihood and consequences of these risks;
- Risk planning
  - Draw up plans to avoid or minimise the effects of the risk;
- Risk monitoring
  - Constantly monitor risks & plans for risk mitigation.

### Risk management process

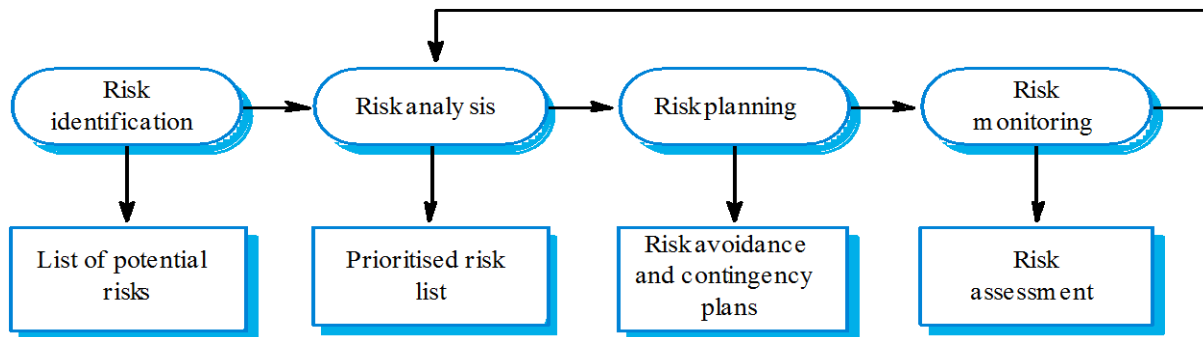

### Risk identification

- Discovering possible risk
- Technology risks.
- People risks.
- Organisational risks.
- Tool risk.
- Requirements risks.
- Estimation risks.

### Risks and risk types

| Risk type      | Possible risks                                                                                                                                                                           |
|----------------|------------------------------------------------------------------------------------------------------------------------------------------------------------------------------------------|
| Technology     | The database used in the system cannot process as many transactions per second as expected.<br>Software components that should be reused contain defects that limit their functionality. |
| People         | It is impossible to recruit staff with the skills required.<br>Key staff are ill and unavailable at critical times.<br>Required training for staff is not available.                     |
| Organisational | The organisation is restructured so that different management are responsible for the project.<br>Organisational financial problems force reductions in the project budget.              |
| Tools          | The code generated by CASE tools is inefficient.<br>CASE tools cannot be integrated.                                                                                                     |



|              |                                                                                                                                                             |
|--------------|-------------------------------------------------------------------------------------------------------------------------------------------------------------|
| Requirements | Changes to requirements that require major design rework are proposed.<br>Customers fail to understand the impact of requirements changes.                  |
| Estimation   | The time required to develop the software is underestimated.<br>The rate of defect repair is underestimated.<br>The size of the software is underestimated. |

### Risk analysis

- Make judgement about probability and seriousness of each identified risk.
- Made by experienced project managers
- Probability may be very low(<10%), low(10-25%), moderate(25-50%), high(50-75%) or very high(>75%). not precise value. Only range.
- Risk effects might be catastrophic, serious, tolerable or insignificant.

| Risk                                                                                           | Probability | Effects       |
|------------------------------------------------------------------------------------------------|-------------|---------------|
| Organisational financial problems force reductions in the project budget.                      | Low         | Catastrophic  |
| It is impossible to recruit staff with the skills required for the project.                    | High        | Catastrophic  |
| Key staff are ill at critical times in the project.                                            | Moderate    | Serious       |
| Software components that should be reused contain defects which limit their functionality.     | Moderate    | Serious       |
| Changes to requirements that require major design rework are proposed.                         | Moderate    | Serious       |
| The organisation is restructured so that different management are responsible for the project. | High        | Serious       |
| The database used in the system cannot process as many transactions per second as expected.    | Moderate    | Serious       |
| The time required to develop the software is underestimated.                                   | High        | Serious       |
| CASE tools cannot be integrated.                                                               | High        | Tolerable     |
| Customers fail to understand the impact of requirements changes.                               | Moderate    | Tolerable     |
| Required training for staff is not available.                                                  | Moderate    | Tolerable     |
| The rate of defect repair is underestimated.                                                   | Moderate    | Tolerable     |
| The size of the software is underestimated.                                                    | High        | Tolerable     |
| The code generated by CASE tools is inefficient.                                               | Moderate    | Insignificant |

### Risk planning

- Consider each identified risk and develop a **strategy** to manage that risk.
- categories

- Avoidance strategies
  - The probability that the risk will arise is reduced;
- Minimisation strategies
  - The impact of the risk on the project will be reduced;
- Contingency plans
  - If the risk arises, contingency plans are plans to deal with that risk. eg: financial problems

### Risk management strategies

| Risk                              | Strategy                                                                                                                                        |
|-----------------------------------|-------------------------------------------------------------------------------------------------------------------------------------------------|
| Organisational financial problems | Prepare a briefing document for senior management showing how the project is making a very important contribution to the goals of the business. |
| Recruitment problems              | Alert customer of potential difficulties and the possibility of delays, investigate buying-in components.                                       |
| Staff illness                     | Reorganise team so that there is more overlap of work and people therefore understand each other's jobs.                                        |
| Defective components              | Replace potentially defective components with bought-in components of known reliability.                                                        |
| Requirements changes              | Derive traceability information to assess requirements change impact, maximise information hiding in the design.                                |
| Organisational restructuring      | Prepare a briefing document for senior management showing how the project is making a very important contribution to the goals of the business. |
| Database performance              | Investigate the possibility of buying a higher-performance database.                                                                            |
| Underestimated development time   | Investigate buying in components, investigate use of a program generator                                                                        |

### Risk monitoring

- Assess each identified risks regularly to decide whether or not it is becoming less or more probable.
- Also assess whether the effects of the risk have changed.
- Cannot be observed directly. Factors affecting will give clues.
- Each key risk should be discussed at management progress meetings & review.

### Risk indicators

| Risk type  | Potential indicators                                                             |
|------------|----------------------------------------------------------------------------------|
| Technology | Late delivery of hardware or support software, many reported technology problems |
| People     | Poor staff morale, poor relationships amongst team member, job availability      |

|                |                                                                                                               |
|----------------|---------------------------------------------------------------------------------------------------------------|
| Organisational | Organisational gossip, lack of action by senior management                                                    |
| Tools          | Reluctance by team members to use tools, complaints about CASE tools, demands for higher-powered workstations |
| Requirements   | Many requirements change requests, customer complaints                                                        |
| Estimation     | Failure to meet agreed schedule, failure to clear reported defects                                            |

### CASE Tools

- Computer-Aided Software Engineering
- Prerequisites to tool use
  - Need a collection of useful tools that help in every step of building a product
  - Need an organized layout that enables tools to be found quickly and used efficiently
  - Need a skilled craftsperson who understands how to use the tools effectively

### CASE Tools

- Upper CASE
  - requirements
  - specification
  - planning
  - design
- Lower CASE
  - implementation
  - integration
  - maintenance

### CASE tool classification

- Functional perspective
- Process perspective
- Integration perspective

### CASE Tool Taxonomy

- Project planning tools
  - used for cost and effort estimation, and project scheduling
- Business process engineering tools
  - represent business data objects, their relationships, and flow of the data objects between company business areas
- Process modeling and management tools
  - represent key elements of processes and provide links to other tools that provide support to defined process activities
- Risk analysis tools
  - help project managers build risk tables by providing detailed guidance in the identification and analysis of risks
- Requirements tracing tools
  - provide systematic database-like approach to tracking requirement status beginning with specification
- Quality assurance tools

- metrics tools that audit source code to determine compliance with language standards or tools that extract metrics to project the quality of software being built
- Documentation tools
  - provide opportunities for improved productivity by reducing the amount of time needed to produce work products
- Database management tools
  - RDMS and OODMS serve as the foundation for the establishment of the CASE repository
- Software configuration management tools
  - uses the CASE repository to assist with all SCM tasks (identification, version control, change control, auditing, status accounting)
- Analysis and design tools
  - enable the software engineer to create analysis and design models of the system to be built, perform consistency checking between models
- Interface design and development tools
  - toolkits of interface components, often part environment with a GUI to allow rapid prototyping of user interface designs
- Prototyping tools
  - enable rapid definition of screen layouts, data design, and report generation
- Programming tools
  - compilers, editors, debuggers, OO programming environments, fourth generation languages, graphical programming environments, applications generators, and database query generators
- Web development tools
  - assist with the generation of web page text, graphics, forms, scripts, applets, etc.
- Test management tools
  - coordinate regression testing, compare actual and expected output, conduct batch testing, and serve as generic test drivers
- Client/server testing tools
  - exercise the GUI and network communications requirements for the client and server

### **CASE tool support**

- Requirements storage
  - Requirements should be managed in a secure, managed data store
- Change management
  - The process of change management is a workflow process whose stages can be defined and information flow between these stages partially automated
- Traceability management
  - Automated retrieval of the links between requirements

### **DBMS Features Needed for CASE Repositories**

- Non-redundant data storage
- High-level access
- Data independence

- Transaction control
- Multi-user support